

# AN11742

## Dynamic Power Control

Rev. 1.4 — 3 December 2016  
345514

Application note  
COMPANY PUBLIC

### Document information

Info	Content
<b>Keywords</b>	PN5180, PN7462, DPC, Dynamic Power Control, TX Shaping, PCD Shaping, Automatic Waveshape Control, AWC
<b>Abstract</b>	This document describes the Dynamic Power Control (DPC) feature of the PN5180 and the PN7462 and how to use it. It describes how to control the wave shapes using the TX Shaping feature in combination with the DPC. It shows examples with the PNEV5180B and the NFC Cockpit.



## Revision history

Rev	Date	Description
1.4	20161203	References to PN7462 added Descriptive title changed Typo in Table 6 corrected
1.3	20160104	Typo in section 2 corrected.
1.2	20151216	Section 4.8 added.
1.1	20151126	Minor update
1.0	20151124	First release

## Contact information

For more information, please visit: <http://www.nxp.com>

## 1. Introduction

The Dynamic Power Control (DPC) is a feature of the P5180 and PN7462 that allows to control the transmitter current and therefore the field strength depending on loading and detuning conditions. The DPC can be enabled and then dynamically adapts the output power neither requiring any additional resource on the host  $\mu$ C nor requiring additional components.

Together with the proper DPC antenna tuning (as described in [2]) the DPC offers an improved RF performance. On one hand the overall Q factor of the antenna coil circuitry can be increased. On the other hand the DPC antenna tuning provides an improved transfer function. So the DPC as such can be used to extend the read range or to use smaller antennas, without exceeding the driver current specification of the NFC Reader IC, and without exceeding the maximum field strength limits as given by the ISO/IEC 14443, NFC or EMVCo standards.

The requirement for a proper function is a DPC antenna tuning according to the given guidelines (refer to [2]) and a **calibration of the DPC** itself.

This calibration must be done per antenna design. It requires to check and ensure the correlation of AGC and ITVDD (as described in section 2) as well as the proper setup of the PN5180 and PN7462 EEPROM (as described in section 3).

**Note:** Only with a proper DPC calibration the function can be guaranteed and it can be guaranteed that the PN5180 or PN7462 is operated within its specification, when using a DPC antenna tuning:

**DPC calibration is a must, when using a DPC antenna tuning!**

A DPC trimming procedure allows the compensation of production tolerances. The trimming must be done per device.

The PN5180 and PN7462 offer a TX Shaping feature, which **can** be used to optimize the pulse shapes (envelope) of the transmitted data per protocol (and bit rate). The TX Shaping in combination with the DPC even allows an **automatic adaptation of the pulse shapes** due to different loading and detuning conditions, which is called Automatic Waveshape Control (AWC).

This document describes the DPC functionality as such, as well as the calibration and trimming steps. It explains, how to adjust the TX Shaping in combination with the DPC.

The **NFC Cockpit** (graphical user interface software), which can be used together with the PN5180 evaluation board (PNEV5180B) or PN7462 evaluation board (PNEV7462B), gives a full access to all required functions and allows an easy DPC calibration and optimization. The board is prepared to connect an own antenna. Then the NFC Cockpit can be used to calibrate the DPC and even optimize other PN5180 or PN7462 settings. All the settings can be stored in the PN5180 or PN7462 EEPROM.

The complete EEPROM content can be “dumped” from the PN5180 or PN7462 into an XML file. This XML file can be uploaded again into the PN5180 (resp. PN7462) EEPROM either with the evaluation board and the NFC Cockpit or it can be used to be programmed into the final reader product. This allows a quick and convenient calibration and optimization without a specific test SW. The application SW (e.g. EMVCo L1 stack) is completely independent from the analog settings.

In case of PN7462 the EEPROM content is part of the firmware build, but still can be handled separately from the code.

**Note:** In the following the DPC is described with the PN5180, but the same is valid for the PN7462, i.e. for the use of the PN7462, the name of PN5180 can be replaced by PN7462, if not otherwise noted.

### 1.1 The principle of DPC

The DPC antenna tuning (refer to [2]) provides an improved transfer function, especially with a low coupling between the PCD and PICC.

Normally the load of any card, any mobile phone or even the Reference PICC itself causes a detuning and a loading of the antenna. Under certain of these loading and detuning conditions it can easily happen, that either the ITVDD limit or the field strength limit is exceeded as indicated in [2].

Therefore a process is needed to control the output power and the driver current, and to adapt it to the loading and detuning, if needed. This process is automatically done with the dynamic power control (DPC).

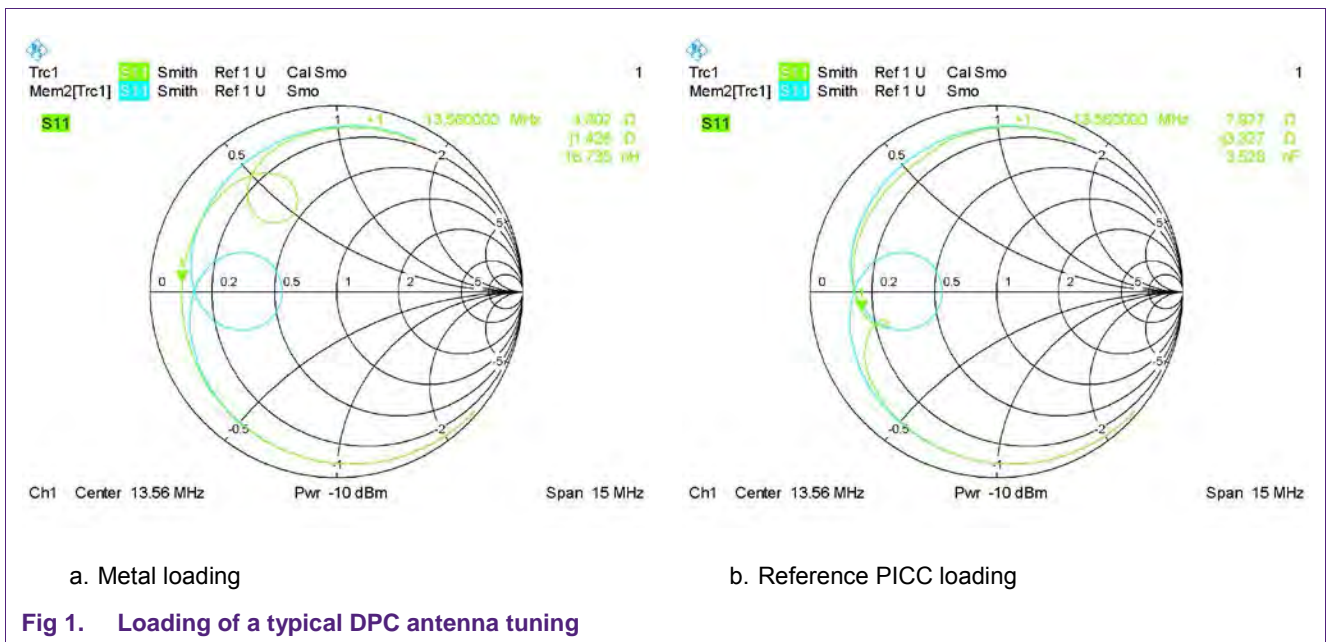

The Fig 1 shows a typical DPC antenna tuning impedance under two different loading conditions. One critical case is shown in Fig 1a, where a metal loading (e.g. a large smart phone) detunes the antenna, while Fig 1b shows the loading and detuning with an EMVCo Reference PICC. In both cases the impedance decreases to values <math><10\Omega</math>. Without a proper DPC the ITVDD limit and also the maximum EMVCo power transfer limit would be exceeded: this might destroy the PN5180 (resp. PN7462).

Fig 2 shows the principle of the dynamic power control, using the block diagram of a typical PCD analog circuitry:

- 1) The load (card or smart phone) decreases the impedance as shown in Fig 1. This causes an increased the driver current ITVDD, which causes an increased output power.
- 2) The increased output power causes an increased voltage level at the Rx input of the PN5180 (resp. PN7462) (i.e. an increased AGC value), which is measured automatically.
- 3) As soon as a certain threshold of the Rx voltage is exceeded, the PN5180 (resp. PN7462) dynamically changes the TX setting and reduces the output power.

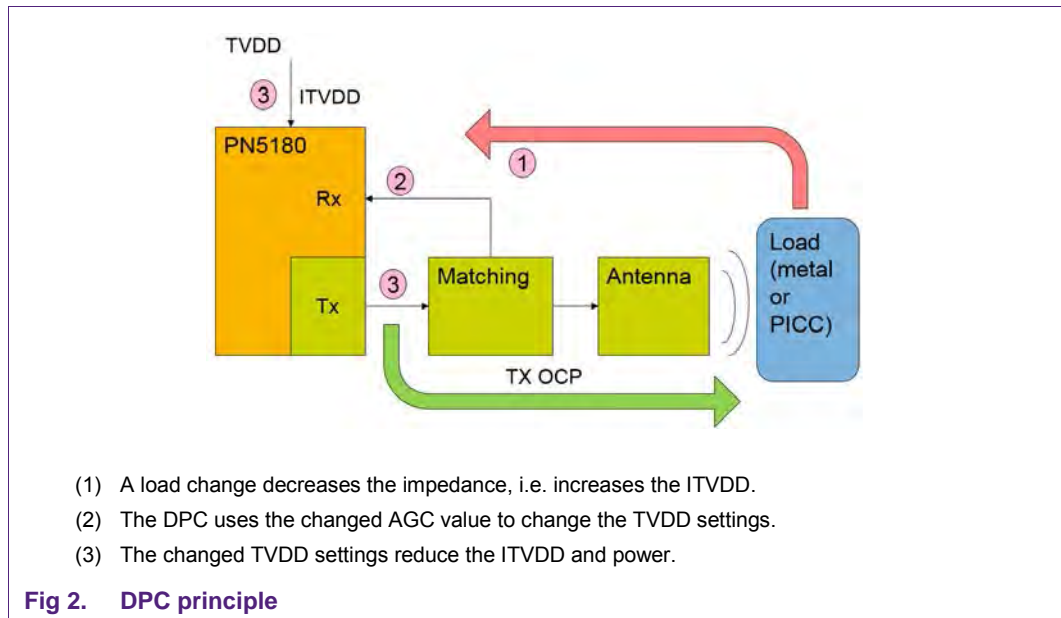

The Fig 3 shows an example of the field strength versus time with and without DPC, when a card is moved closer and closer to the antenna and then removed again.

The dotted line shows the field strength without DPC. This value might exceed the maximum allowed limit.

The PN5180 (resp. PN7462) Dynamic Power Control uses gears to control the output power. Up to 15 gears can be stored, i.e. up to 15 output power steps can be defined. Gear 0 defines the maximum available power, and the highest available gear (e.g. Gear 14) defines the lowest available output power.

The PN5180 (resp. PN7462) dynamically measures the AGC value. The typical time interval of this measurement can be defined by the user (DPC\_TIME).

In the shown example a card is entered into the antenna field, which increases the load, and therefore the output power. As soon as the measured AGC value exceeds the AGC high threshold value of the corresponding gear (DPC\_THRSH\_HIGH), the PN5180 (resp. PN7462) automatically switches to the next gear with lower output power. This automatically reduces the measured AGC value, until the card is moved closer to the antenna.

The PN5180 (resp. PN7462) in the example in Fig 3 switches from gear 0 down to gear 3 in 3 steps to reduce the output power step by step, before the card is removed again, which causes the PN5180 (resp. PN7462) to switch back gear by gear.

For switching back from a lower to a higher output power the current AGC value must become lower than an AGC low threshold value. This AGC low threshold value is dynamically set by the PN5180 (resp. PN7462) itself to properly avoid an oscillation. The user must define a proper “delta” value, which is used to set this low threshold. This “delta” is defined using a shift value, which is stored in the DPC\_AGC\_SHIFT\_VALUE.

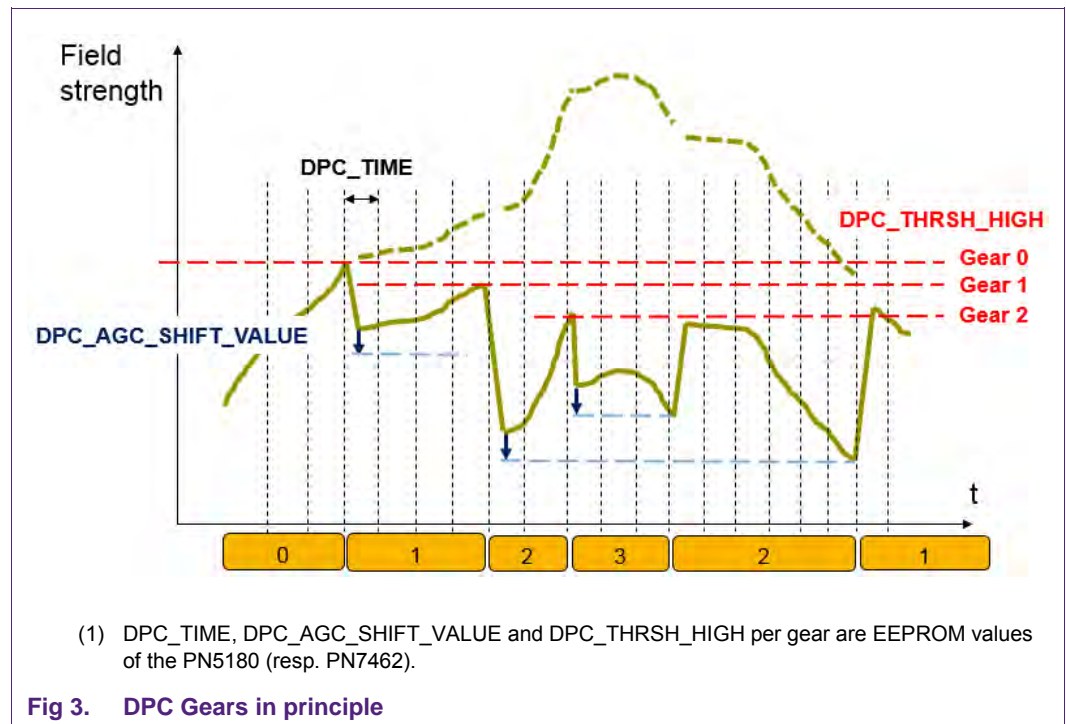

## 1.2 Parameters of DPC

The Table 1 shows the **most relevant** parameters of the dynamic power control, which must be defined during the calibration process.

**Table 1. Relevant parameters of the DPC (PN5180)**

EEPROM Adr	Name	Description
0x59	DPC_CONTROL	Bit 0 enables the DPC Bit 1..3 define the gear step size (default = 1) Bit 4...7 define the start gear (= highest gear!)
0x81	DPC_AGC_GEAR_LUT_SIZE	This value defines the number of gears. Minimum = 1 = 0x01, maximum = 15 = 0x0F
0c82 ... 0x90	DPC_AGC_GEAR_LUT	Up to 15 output power settings 1 byte per gear. Definition refer to section 1.2.3.
0x5F ... 0x7C	DPC_THRSH_HIGH	Up to 15 AGC high threshold values

EEPROM Adr	Name	Description
		2 bytes per gear DPC switches to the next gear, as soon as the current AGC > DPC_THRSH_HIGH
0x80	DPC_AGC_SHIFT_VALUE	Dynamic low threshold adaptation DPC defines the AGC low threshold due to the first measurement after switching to next higher gear: AGC low threshold = current AGC value – (current AGC value >> DPC_AGC_SHIFT_VALUE)
0x95 ... 0x96	DPC_GUARD_FIELD_ON	Defines the guard times after gear switch only during the RF field on. The time is based on 1/20 MHz. There is an offset of ≈51µs.
0x5C	DPC_XI	AGC trim value for production trimming

Note: The EEPROM addresses of PN7462 depend on the firmware build and therefore are different from the addresses given in Table 1. For details refer to [3].

### 1.2.1 DPC\_CONTROL

#### 1.2.1.1 Bit 0: Enable DPC

Normally the DPC should be enabled (must be enabled, if a DPC antenna tuning is used), but the PN5180 (resp. PN7462) works properly without DPC, when using the standard antenna tuning.

Default = 1 (enabled)

**Note:** Sometimes it is required to disable the DPC for test purpose. Disabling the DPC via DPC\_CONTROL requires the user to adjust the TX settings manually in the registers. Therefore it might be easier to enable the DPC in the DPC\_CONTROL, 0x59, but then reduce the number of gears to 1 (in the DPC\_AGC\_GEAR\_LUT\_SIZE, 0x81). Then the DPC is forced to one gear only, and the first entry in the LUT (0x82) automatically defines the TX setting.

#### 1.2.1.2 Bit 1...3: Gear step size

With the gear step size the DPC allows to switch > 1.

Default = 001bin (step size = 1)

#### 1.2.1.3 Bit 4...7: Start gear

The bits 4...7 defines the gear, which is used after the RF field is switched on. Normally a higher gear with the lowest possible output power is used to avoid overcurrent, when switching on the field.

### 1.2.2 DPC\_AGC\_GEAR\_LUT\_SIZE

The DPC\_AGC\_GEAR\_LUT\_SIZE defines the number of gears. The minimum can be 1 gear, at maximum 15 gears can be used. A typical EMVCo POS design might use 5 gears.

The Fig 4 shows the example of switching on the field using 5 gears (gear 0 ...gear 4), with the gear 4 to be the start gear (as to be set in DPC\_CONTROL).

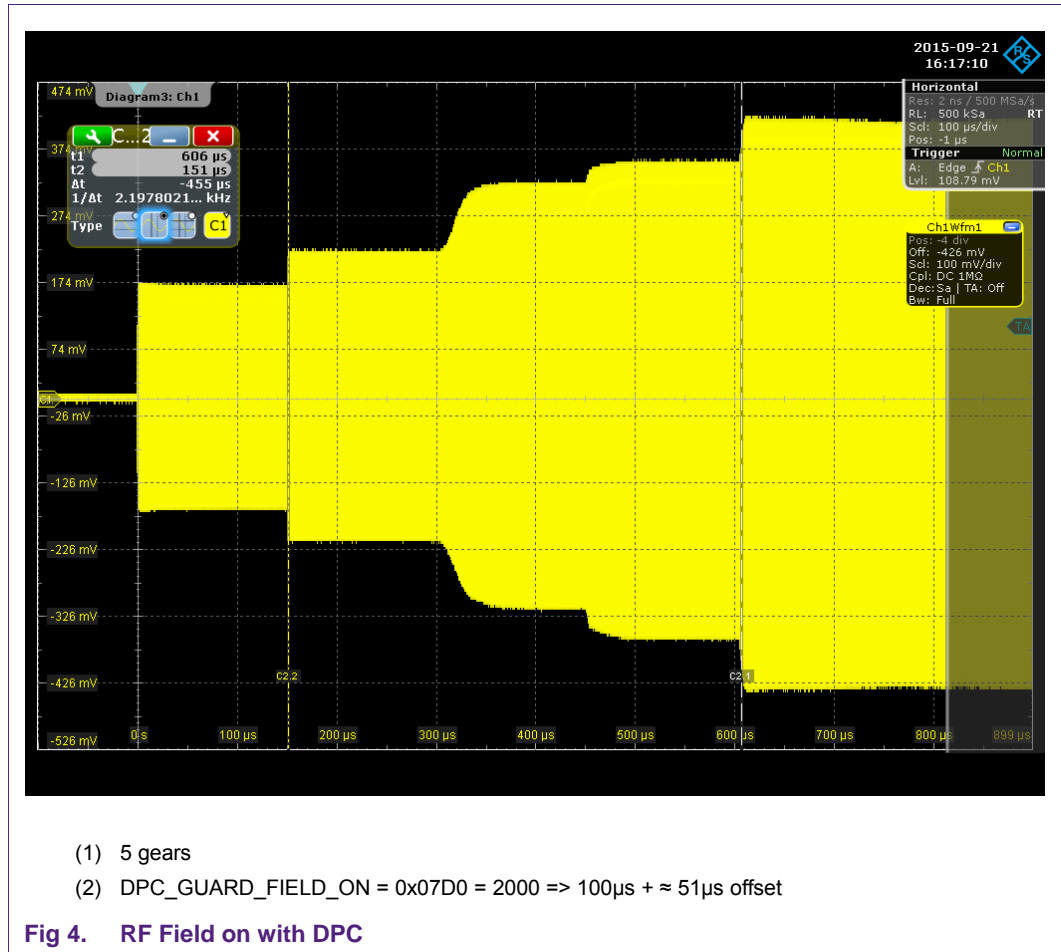

### 1.2.3 DPC\_AGC\_GEAR\_LUT (TX Output power settings)

Each gear defines a different TX output power setting. The lowest gear uses a setting with the highest output power. The gear x+1 always uses a lower output power than gear x.

For each gear the TX output power setting can and must be defined, using the DPC\_AGC\_GEAR\_LUT. The possible settings are shown in Fig 5 and Table 2.



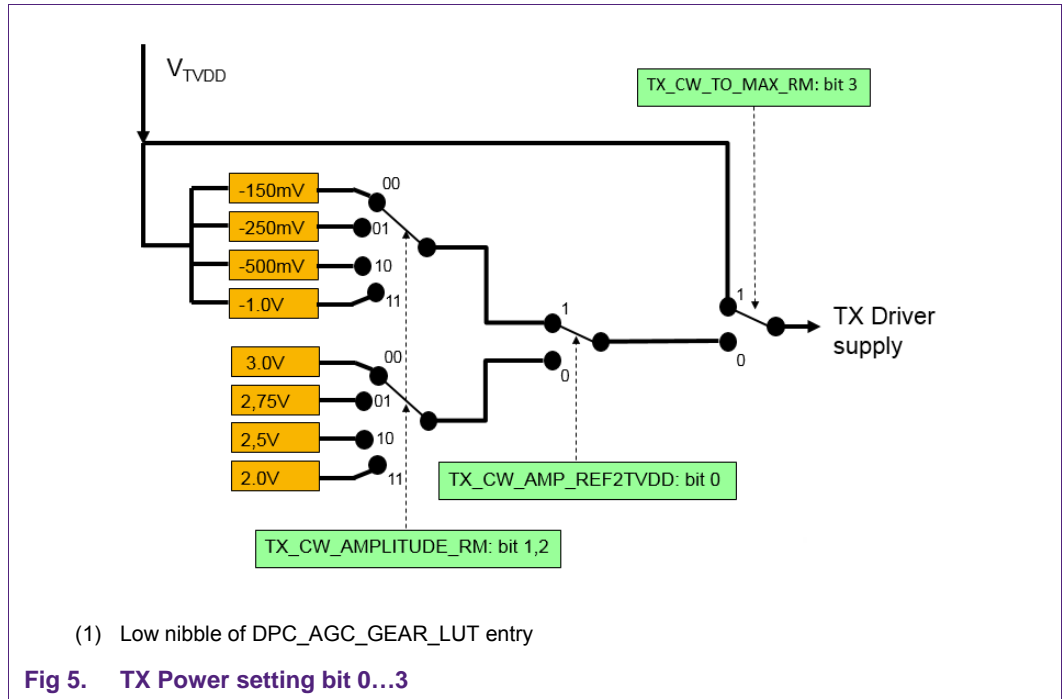

**Table 2. TX Power Settings (bit 7...0)**

Bit 11 ... 8 are not taken into account.

Bit	Name	Description
0	TX_CW_AMP_REF2TVDD	1: TX supply = TVDD – TX_CW_AMPLITUDE_RM 0: TX supply = 3V – TX_CW_AMPLITUDE_RM
2...1	TX_CW_AMPLITUDE_RM	00 = 150mV 01 = 250mV 10 = 500mV 11 = 1V
3	TX_CW_TO_MAX_RM	1: maximum power (TX supply = TVDD) 0: TX supply due to TX_CW_AMP_REF2TVDD & TX_CW_AMPLITUDE_RM
7...4	TX_GSN_CW_RM	0000: lowest power level 1111: highest power level
11 ... 8	Don't care	Are not taken into account

Table 3 shows the example of TX output power settings for 15 gears, Table 4 shows the example for 5 gears. The address 0x81 is shown for reference, indicating the number of valid gears (DPC\_AGC\_GEAR\_LUT\_SIZE), as taken into account by the PN5180 (resp. PN7462) DPC.

The column 5 shows the ITVDD value of the example, the column 6 the DC voltage level, measured at the EMVCo Reference PICC, positioned in 4cm above the antenna. The settings for the 5 gears in Table 4 are chosen in a way to achieve similar steps in the ITVDD between each gear.

**Table 3. Example of Tx Output settings (15 gears)***Example voltage: Reference PICC in constant distance*

Gear #	EEPROM (PN5180)	EEPROM (PN7462)	TX power setting (hex)	Driver voltage (V)	Example ITVDD (mA)	Example voltage @ RefPICC (V)
	0x81	0x201356	0F			
0	0x82	0x201357	F9	5.0	220	3.09
1	0x83	0x201358	F1	4.85	220	3.08
2	0x84	0x201359	F3	4.75	219	3.07
3	0x85	0x20135A	F5	4.5	213	2.99
4	0x86	0x20135B	F7	4.0	187	2.62
5	0x87	0x20135C	F0	2.85	141	1.85
6	0x88	0x20135D	F2	2.75	130	1.61
7	0x89	0x20135E	F4	2.5	118	1.33
8	0x8A	0x20135F	F6	2.0	96	0.75
9	0x8B	0x201360	96	2.0	95	0.74
10	0x8C	0x201361	66	2.0	93	0.70
11	0x8D	0x201362	46	2.0	90	0.63
12	0x8E	0x201363	36	2.0	87	0.57
13	0x8F	0x201364	26	2.0	81	0.44
14	0x90	0x201365	16	2.0	64	0.08

**Table 4. Example of Tx Output power settings (5 gears)***Example voltage: Reference PICC in constant distance*

Gear #	EEPROM	EEPROM (PN7462)	TX power setting (hex)	Driver voltage (V)	Example ITVDD (mA)	Example voltage @ RefPICC (V)
	0x81	0x201356	05			
0	0x82	0x201357	F9	5.0	220	3.09
1	0x83	0x201358	F7	4.0	187	2.62
2	0x84	0x201359	F0	2.85	141	1.85
3	0x85	0x20135A	F6	2.0	96	0.75
4	0x86	0x20135B	26	2.0	81	0.44

The Fig 6 shows the ITVDD for 5 gears unloaded and with two different loading examples.

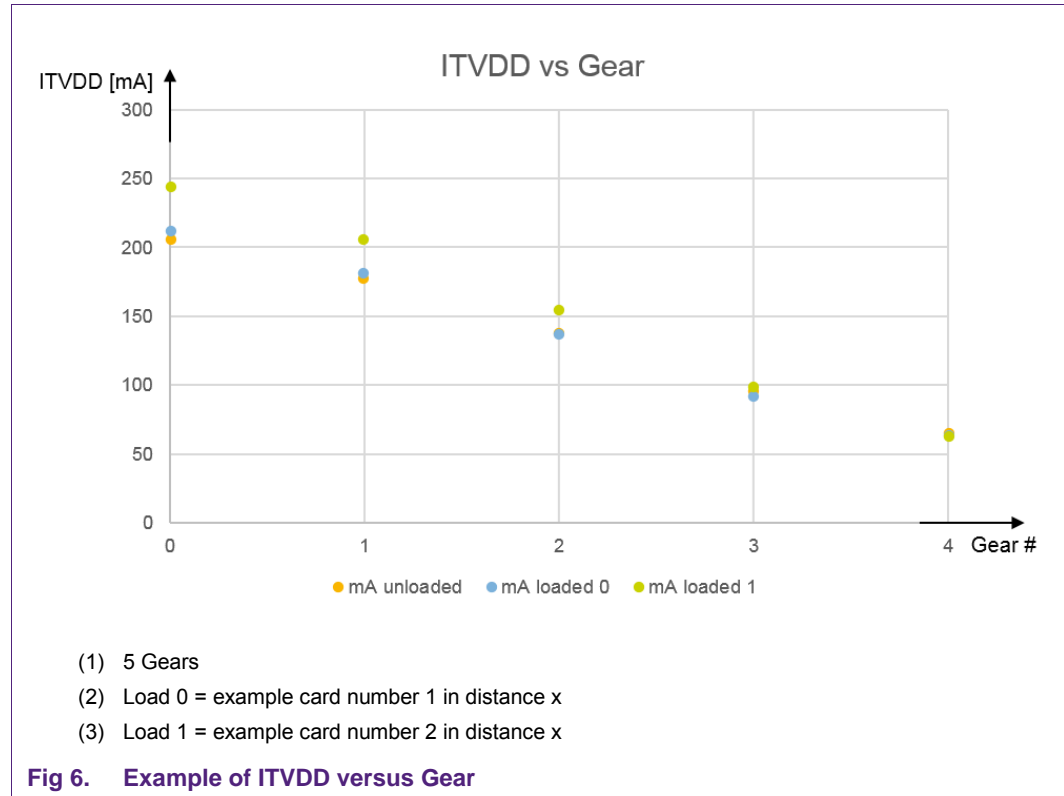

### 1.2.4 DPC\_THRSH\_HIGH

For each gear an AGC high threshold must be defined and stored in the EEPROM. Normally the maximum allowed ITVDD is linked to this threshold, since any higher AGC value makes the PN5180 (resp. PN7462) switch to the next gear with lower output power.

The threshold for each gear should be chosen in a way that

- 1) The maximum ITVDD stays < 220mA. (Safety margin!)
- 2) The maximum field strength < 7.5 A/m (ISO/IEC 14443 Class1) or the maximum power transfer < 8.0V (EMVCo).

The easiest way to define and store the threshold values per gear is to use the NFC Cockpit (the PN5180 or PN7462 GUI), as described in section 3.3.

1.2.4.1 DPC\_THRS\_HIGH Example with 5 gears

Table 5 shows an example of 5 gears and the corresponding threshold values, when using the antenna tuning example of [2].

**Table 5. Example measurement of DPC\_THRS\_HIGH**

*The Rx resistor = 3KΩ leads to a nominal AGC value unloaded of 369.*

Gear #	AGC (hex)	AGC (dec)	Loading	ITVDD
0	171	369	Unloaded	141
0	1C7	455	1	180
1	18A	394	1	151
1	1C2	450	2	180
2	175	373	2	141
2	1C4	452	3	180
3	14A	330	3	123
3	1A7	423	4	180
4	130	304	4	118
4	143	323	5	122

**Step 1: Unloaded**

The Rx resistor was chosen to be  $R = 3.0\text{ k}\Omega$ . The measurement shows the AGC value of 369 in gear 0, driving  $ITVDD = 139\text{mA}$  (unloaded). The recommended AGC value is 300, so in this case the Rx resistor could be slightly increased.

However, AGC values in the unloaded case of up to 600 are allowed, as soon as the PN5180 (resp. PN7462) is used in the PCD mode only.

**Step 2: Gear 0 Threshold**

For the correct calibration the load must be increased, until the threshold is reached. In this example the threshold was chosen to be  $ITVDD = 180\text{mA}$ . This threshold should stay below  $220\text{mA}$  to stay within the maximum allowed  $ITVDD$  under all frame conditions (temperature and component tolerances). With  $ITVDD < 180\text{mA}$  the EMVCo limits can be met with this example.

The operating distance, using the EMVCo Reference PICC, is carefully reduced, until the  $ITVDD = 180\text{mA}$ . The related AGC value = 455 (=0x01C7) is taken as threshold for gear 0 and therefore stored into the EEPROM (0x59 & 0x5A), see Table 6.

**Step 3: Gear 1 Threshold**

Now the gear must be switched to gear 1, which then reduces the output power. The Table 5 shows that the  $ITVDD$  drops from  $180\text{mA}$  to  $151\text{mA}$ , when switching to gear 1. The AGC value drops accordingly to 394.

Then the load must be increased, i.e. the operating distance again must be carefully reduced, until the  $ITVDD = 180\text{mA}$ . The measurement of the corresponding AGC reads  $AGC = 450$  (0x01C2). This is the threshold for the gear 1 and must be stored into the EEPROM (0x5B & 0x5C), see Table 6.

**Step 4: Gear 2 Threshold**

Again the gear must be switched now to the next gear, which then reduces the output power. Then the operating distance must be further decreased, until the ITVDD = 180mA. The corresponding AGC value is the threshold value for the gear 2.

**Step 5: all other thresholds**

These steps are continued gear by gear, until the maximum load (Reference PICC and any load in zero distance), and / or the last gear with the lowest output power is reached. Out of this the AGC threshold table for all used gears should be completely stored in the EEPROM as shown for the example in Table 6.

**Table 6. Example PN5180 EEPROM content for DPC\_THRSH\_HIGH**  
*Due to the measurement results from Table 5.*

EEPROM Adr	Hex	Remark	Gear #
0x5F	C7	Low byte of high threshold	0
0x60	01	High byte of high threshold	0
0x61	C2	Low byte of high threshold	1
0x62	01	High byte of high threshold	1
0x63	C4	Low byte of high threshold	2
0x64	01	High byte of high threshold	2
0x65	A7	Low byte of high threshold	3
0x66	01	High byte of high threshold	3
0x67	43	Low byte of high threshold	4
0x68	01	High byte of high threshold	4

Now the DPC is calibrated and can be used.

**1.2.5 DPC\_AGC\_SHIFT\_VALUE**

The AGC low threshold is automatically calculated by the PN5180 (resp. PN7462) itself to avoid an oscillation. The calculation parameter can be set in the EEPROM, using the DPC\_AGC\_SHIFT\_VALUE. The DPC\_AGC\_SHIFT\_VALUE defines the hysteresis for the gear switch in form of a shift value.

The AGC low threshold is calculated after the gear has switched, i.e. after the output power (and the AGC value) has decreased:

$$\text{Dynamic AGC low threshold} = \text{new AGC} - (\text{new AGC} \gg \text{DPC\_AGC\_SHIFT\_VALUE})$$

Recommendation: do not change the DPC\_AGC\_SHIFT\_VALUE.

**Example:**

$$\text{DPC\_AGC\_SHIFT\_VALUE} = 5$$

The AGC after switching from gear 0 to gear 1 might be 394(dec). Shifting 5 bits to the right (= dividing through 32) results in 12(dec). So the dynamic AGC low threshold for gear 1 becomes 382(dec) = 0x17E.

The default DPC\_AGC\_SHIFT\_VALUE = 0x05.

The higher the DPC\_AGC\_SHIFT\_VALUE gets, the smaller the hysteresis between AGC value after gear switch and the dynamic AGC low threshold becomes.

A lower DPC\_AGC\_SHIFT\_VALUE increases the hysteresis.

### 1.2.6 DPC\_XI

Due to production tolerances the AGC values can vary by +/- 30 AGC steps. Therefore the DPC allows a trim procedure correct this variation. This trim procedure corrects the AGC values based on a correction or trim value: DPC\_XI.

This trim value must be derived and then stored in the EEPROM (PN5180: 0x5C: PN7462: 0x201353) for every PN5180 (resp. PN7462) device, i.e. for every reader device during production.

#### 1.2.6.1 Define Reference AGC value

The first and original DPC antenna tuning and the DPC calibration is done with a PN5180 (resp. PN7462) device, using the DPC\_XI = 0. This device can be seen like a reference device ("golden device").

The Reference AGC value must be read, using gear 0 under unloaded condition (read RF\_STATUS register, bit 0 ...9). This Reference AGC will be used for the Trim procedure later on during production.

#### 1.2.6.2 Trim production device

For each production device, i.e. for all devices other than the "golden device", the current AGC value must be read, using gear 0 under unloaded condition (read RF\_STATUS register, bit 0 ...9).

Note: It might be required to "force" the device into gear 0, since the DPC settings, which are based on the Reference AGC might switch gear already under unloaded conditions.

Then the DPC\_XI can be calculated:

DPC\_XI value = Reference AGC value – current AGC value

Then the DPC\_XI must be stored into the EEPROM (0x5C).

**Note:** The DPC\_XI value might be negative using the complement on two.

## 2. DPC Correlation test

The DPC uses the AGC value to control the output power, i.e. the ITVDD. Therefore it requires a correlation between the ITVDD and the AGC value to allow a proper control mechanism, as shown in Fig 7.

This correlation normally is achieved, if

1. The DPC antenna tuning is applied, i.e. the impedance shows the “symmetrical” tuning behavior
2. The  $L_0 \geq L_{\text{antenna}}/2$

However, it is strongly recommended to check the correlation for each antenna tuning separately. So one of the first things after antenna tuning is the DPC Correlation test.

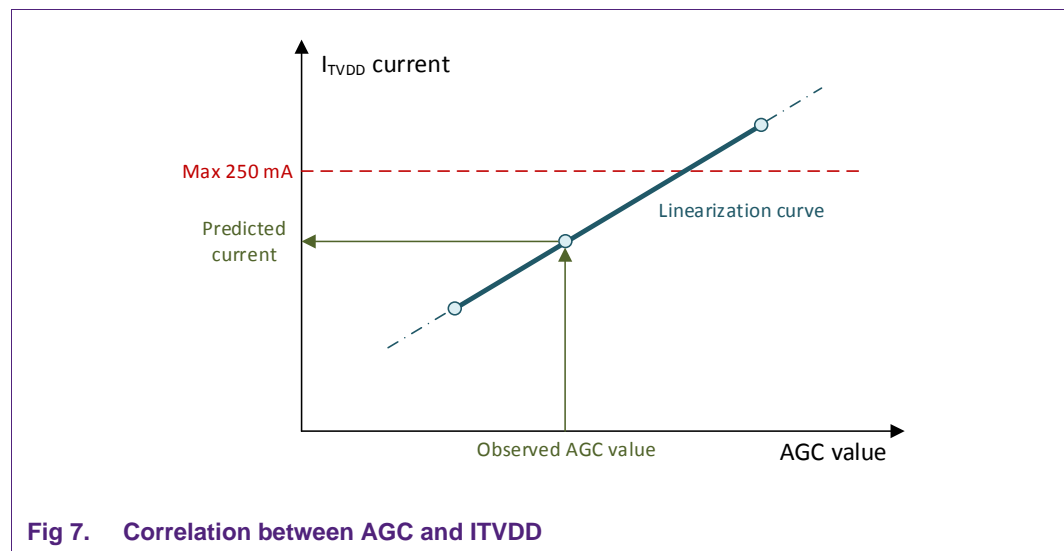

Fig 7. Correlation between AGC and ITVDD

### 2.1 Correlation test

The correlation test needs to be done with different types of loading to ensure a proper correlation between AGC value and ITVDD for any loading condition.

The easiest way to test this is to define at least two different types of “worst case” loading, e.g. loading with a reference PICC and loading with a smart phone (metal).

These two type of loadings typically show opposite behavior in terms of detuning: typically the EMVCo Reference PICC turns the impedance curve in the smith chart clockwise, while a metal loading like a smart phone typically turns the curve counter clockwise (refer to Fig 1).

For each of these loading conditions the ITVDD versus AGC value should be measured. The result can be shown in a diagram like shown in Fig 8.

Fig 8a shows a good correlation, where the correlation between AGC value and ITVDD is “linear” enough and also close enough between the two different loading conditions. This tuning can be used to calibrate the DPC.

Fig 8b shows a bad correlation. In this example a too low value of L0 has been chosen. This results in a non-linear behavior. Certain AGC values correspond to multiple ITVDD (= output power levels). With this antenna tuning the DPC will not work.

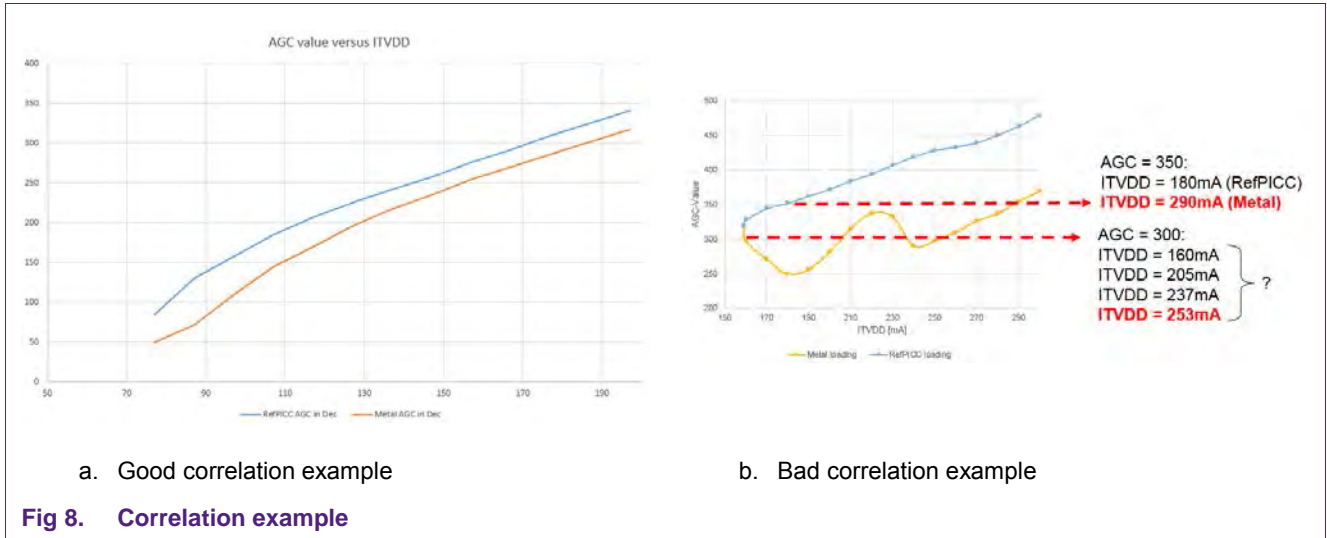

The correlation test is supported by the NFC Cockpit.

## 2.2 Correlation test with the NFC Cockpit

The easiest way to perform a correlation test is to use the NFC Cockpit.

### 2.2.1 PN5180

The PN5180 Evaluation board with the tuned antenna must be connected to the PC via USB.

**Note:** Alternatively the NFC Cockpit VCOM version can be used on the final reader hardware, as soon as VCOM interface is supported by it.

An ITVDD measurement is required to perform the correlation test and the DPC calibration itself, e.g. connecting an Ampere meter at jumper JP3, as shown in Fig 9.



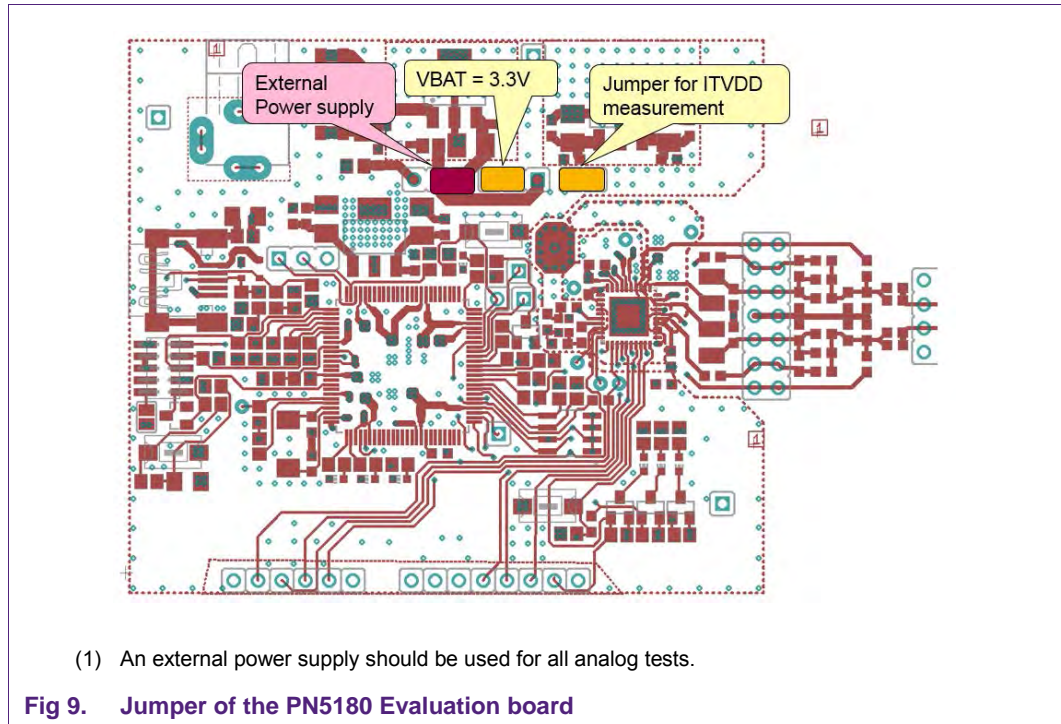

**Note:** All analog tests must be done with a proper power supply, especially for the TVDD. For the PN5180 evaluation board that means either an external power supply with at least 7.5 (AC or DC) is connected to the power plug of the evaluation board, or the TVDD is supplied directly by an external power supply, e.g. using the TVDD pin of the jumper JP3.

**Note:** In the final hardware the same applies, i.e. the hardware must provide a proper power supply and the ITVDD must be measurable, if the final hardware in combination with the VCOM version of the NFC Cockpit is used for the correlation test.

### 2.2.2 PN7462

The PN7462 Evaluation board with the tuned antenna must be connected to the PC via USB.

An ITVDD measurement is required to perform the correlation test and the DPC calibration itself, e.g. connecting an external power supply to jumper JP16, as shown in Fig 10.

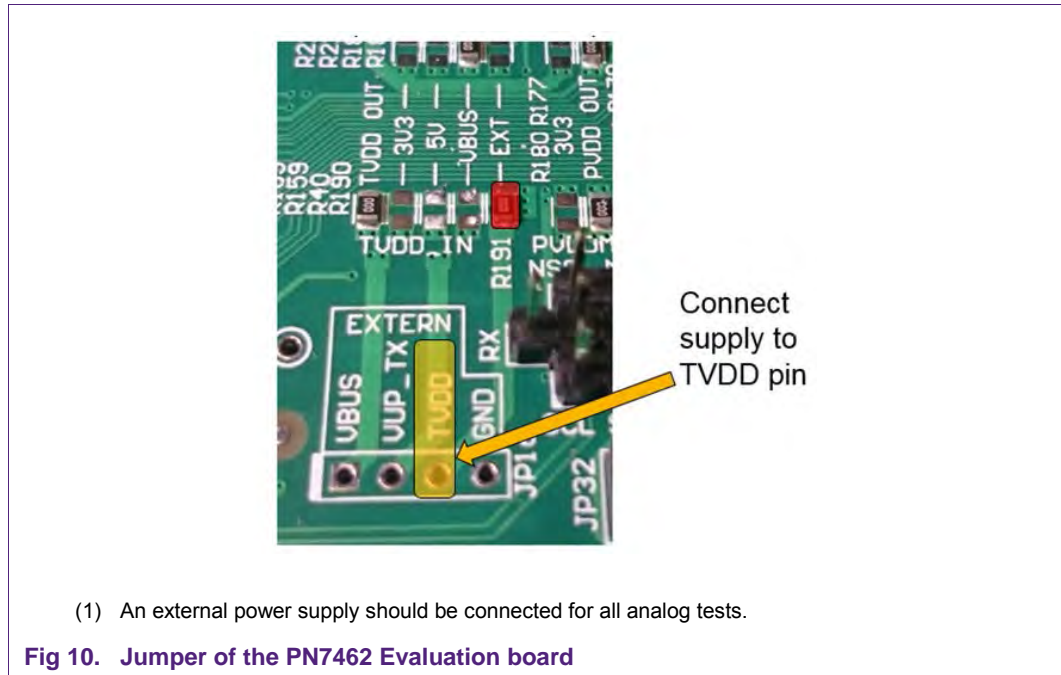

### 2.2.3 Step 1: ITVDD unloaded

The first step of the correlation test is to measure and enter the ITVDD under no loading. The protocol settings of Type A should be loaded, and then the RF field must be switched on.

**Note:** It might be good to limit the external ITVDD to avoid damage, in case the antenna tuning is wrong, or some external load detunes the antenna too much and therefore increases the ITVDD too much. This might easily exceed the allowed limit before the DPC is calibrated and enabled.

The measured ITVDD (unloaded) must be entered into the NFC Cockpit as shown in Fig 11, Step 1. This ITVDD value is the starting point of the correlation test.

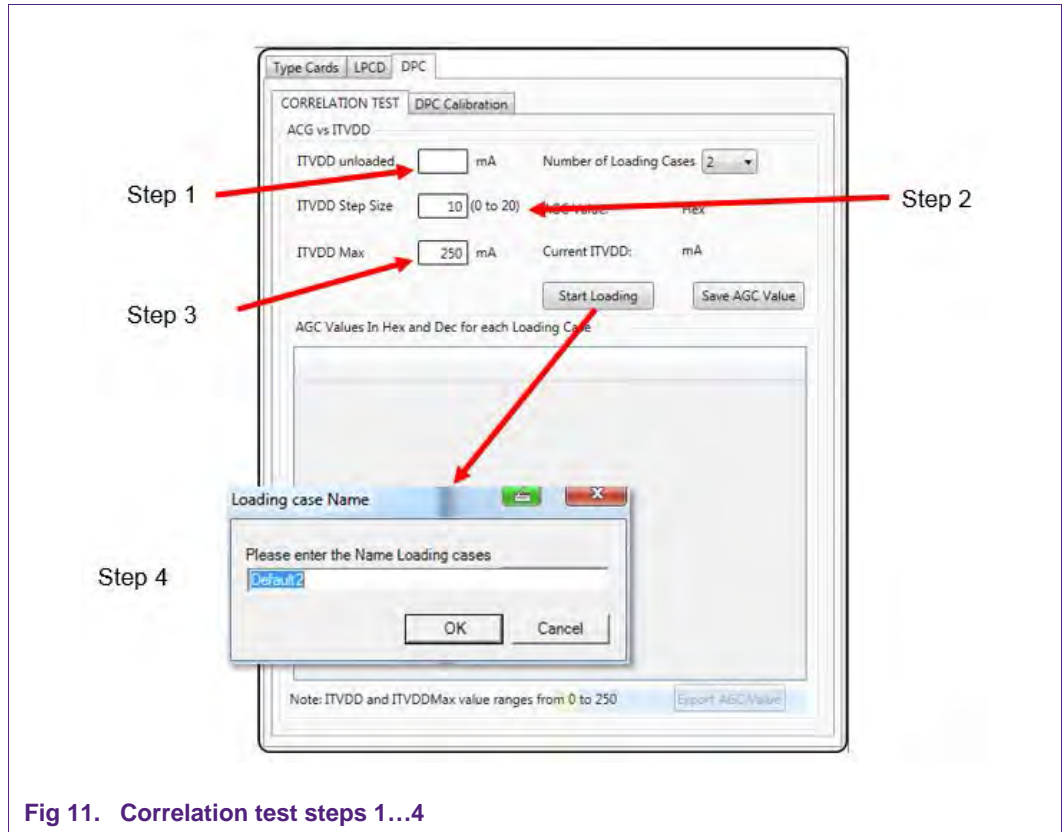

Fig 11. Correlation test steps 1...4

**2.2.4 Step 2: Step size**

Then the step size must be defined, as shown in Fig 11, step 2. The correlation test is done in steps of ITVDD, starting with the ITVDD unloaded, using the defined step size. The smaller the step size is, the more steps are tested. Typically a step size of 10mA is a good choice.

**2.2.5 Step 3: ITVDD max**

The next required entry is the maximum limit of the ITVDD, at which the test will be stopped, as shown in Fig 11, step 3.

The default value is the maximum allowed ITVDD of 250mA.

**2.2.6 Step 4: Start correlation test**

Per default two loading cases are tested, but of course more can be chosen. As mentioned in section 2, two loading cases with the opposite detuning behavior normally are sufficient. So typically the loading with a Reference PICC as well as with a large smart phone (= piece of metal) should be tested.

When the correlation is started, an entry field appears as shown in Fig 11, which asks for a name of the first loading case. A meaningful name can be entered, e.g. "Reference PICC" or "Metal". This name is used to indicate the test results related to this loading case in the later result table.

**2.2.7 Step 5: ITVDD / AGC measurement loading case 1**

The starting point of the correlation test is the minimum ITVDD under unloaded condition. The previously entered ITVDD unloaded appears as well as the corresponding AGC value as shown in Fig 12.

**Note:** The example as shown in Fig 16 uses an example antenna tuning with ITVDD = 77mA unloaded.

For the first step the loading condition (unloaded) must be valid to achieve the given ITVDD, and then the value must be stored by pressing the <Store AGC Value>. Another info window appears, indicating the pair of ITVDD and corresponding AGC value, which then will be stored.

When stored, the first line of the measurement table will be shown, indicating the ITVDD and the AGC value in hexadecimal and decimal.

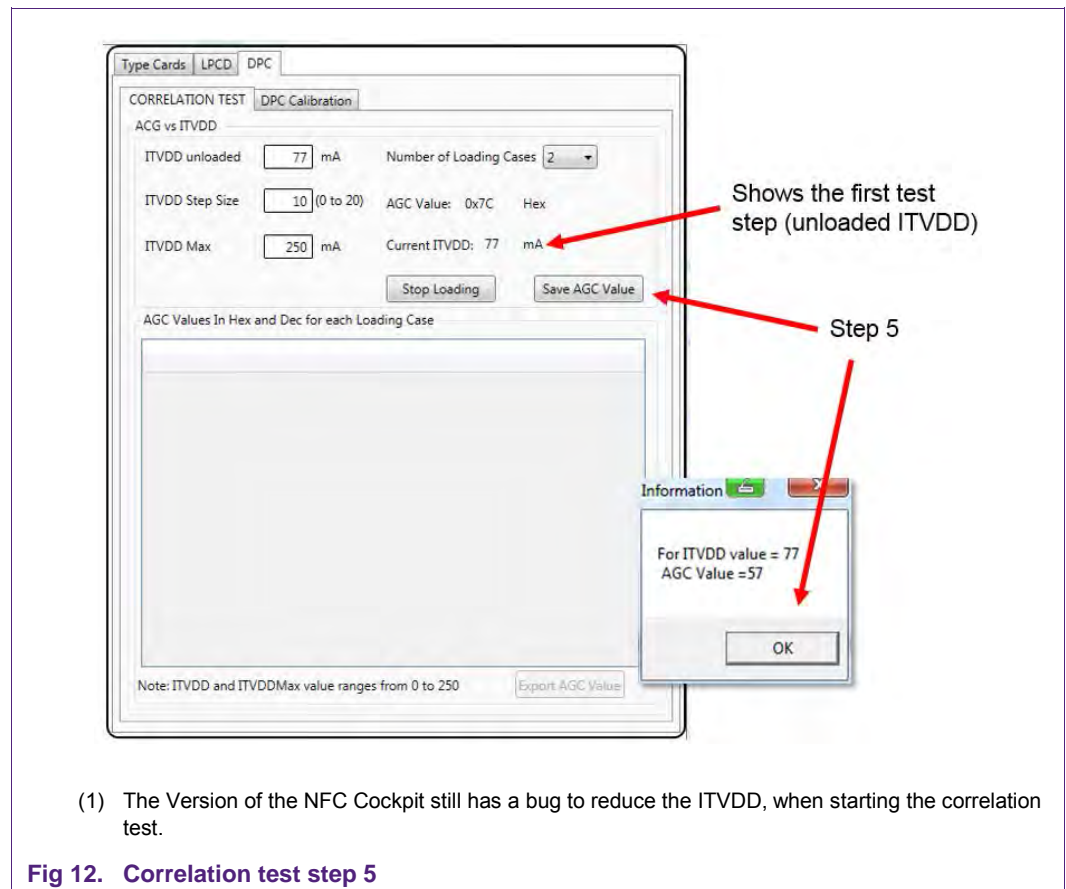

The ITVDD given by the NFC Cockpit is then automatically increased by the step size (e.g. 10mA).

Now the load on the antenna must be changed: the operating distance of the Reference PICC (or metal or whatever the first loading case is) must be changed in such a way that

the ITVDD measurement (using the Ampere meter) shows the same ITVDD value as the NFC Cockpit.

As soon as the Ampere meter shows the given (required) ITVDD, the AGC Value must be stored (<Store AGC Value>). Then the NFC Cockpit again increases the given (required) ITVDD by one step.

This measurement then must be continued step by step: the load must be adapted always to meet the given (required) ITVDD, and then the corresponding AGC Value must be stored (<Store AGC Value>).

**2.2.8 Step 6: ITVDD / AGC measurement loading case 2**

When the maximum ITVDD is reached the NFC Cockpit automatically starts the second part of the correlation test, using the “opposite” loading, e.g. metal, as shown in Fig 13.

This second part then must be executed in the same way like the first part (step 5), except that the different load is used.

(1) The AGC values do not exceed 328(dec) since the loading cannot be increased any further than ITVDD = 190mA, when using the Reference PICC as load.

**Fig 13. Correlation test start of second loading case**

2.2.9 Step 7: Store the result

As soon as the last measurement is done, the NFC Cockpit allows the export of the table, as shown in Fig 14.

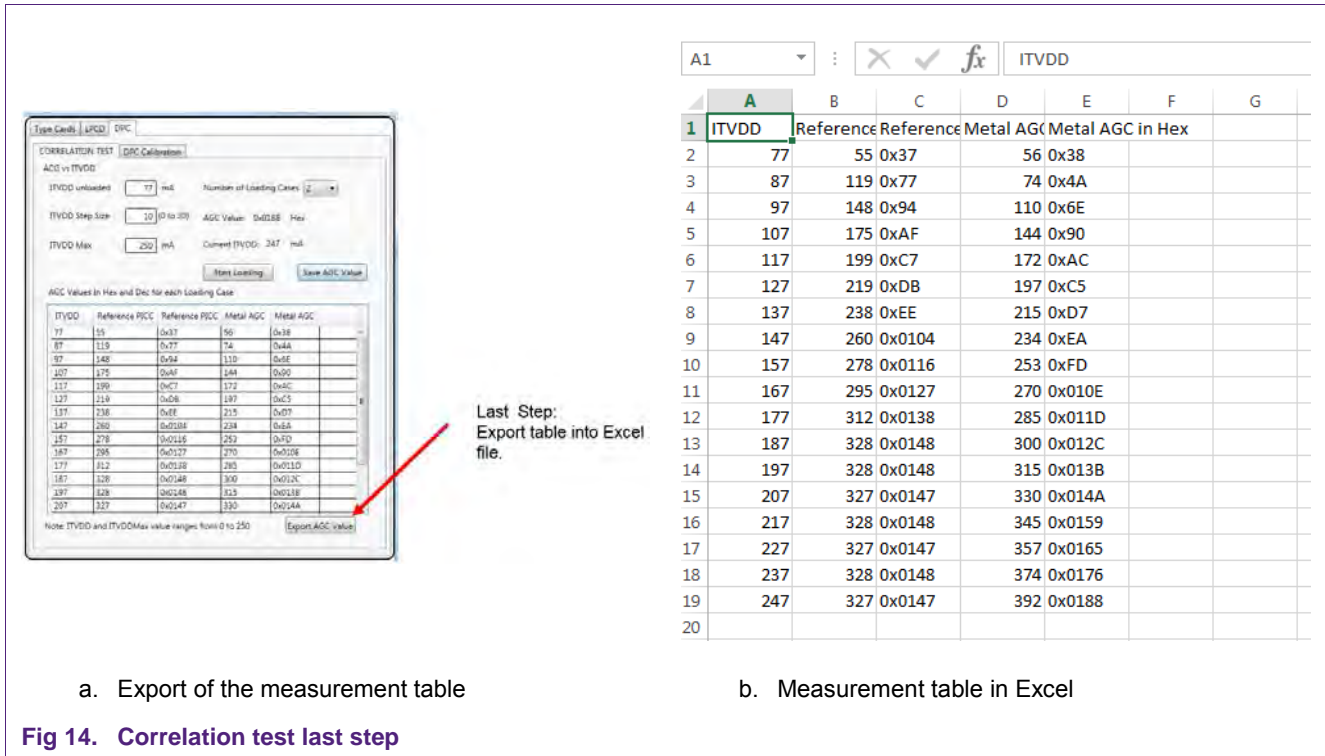

This table then can be opened e.g. with Microsoft Excel to easily draw a graph as shown in Fig 15.

**Note:** In the shown result the AGC value does not exceed 328 for the loading case 1 (“Reference PICC”). In that case the load (=Reference PICC) was already in zero distance laying on the PCD antenna, so no further increase of ITVDD (and AGC) was possible.



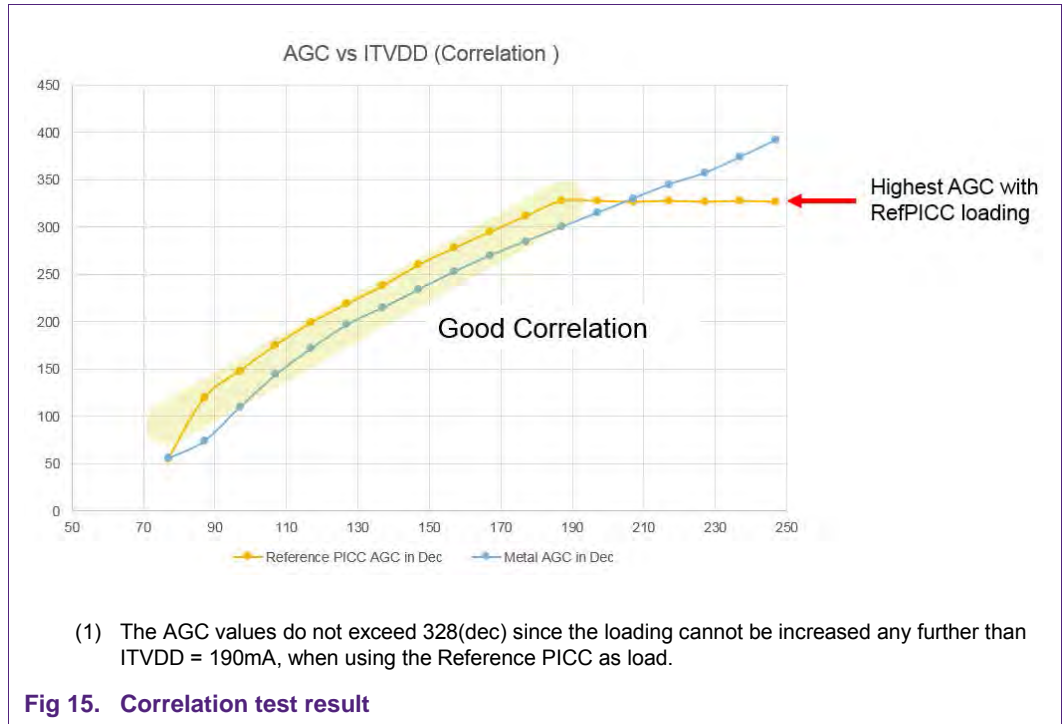

### 3. DPC calibration

The DPC calibration must be done to operate a DPC antenna. This calibration defines the AGC threshold values, which make the PN5180 (resp. PN7462) change to the next gear, i.e. which make the PN5180 (resp. PN7462) decrease the output power.

#### 3.1 Prerequisites

The DPC calibration requires a DPC antenna tuning (refer to [2]), which meets the correlation requirement as indicated above.

It makes sense to test the Tx wave shapes at least in the “unloaded” case, i.e. in the position with the lowest possible coupling between the PCD antenna and the Reference PICC. In case of EMVCo this is the position in 4cm above the antenna. All other positions should be checked and adjusted later, when the DPC is working.

The Rx coupling resistors must be adjusted to achieve an AGC value of at least 300 unloaded.

**Note:** The optimum unloaded AGC value for a pure PCD functionality (only NFC Reader mode) is  $\approx 600$ . As soon as the device shall support all NFC modes, the unloaded AGC value should be  $\approx 300$ .

#### 3.2 DPC Calibration minimum requirements

This calibration requires the definition of at least

1. **Number of gears** (DPC\_AGC\_GEAR\_LUT\_SIZE)  
Details refer to section 1.2.2.
2. **Tx Settings per gear** (DPC\_AGC\_GEAR\_LUT)  
Details refer to section 1.2.3.

3. **Dynamic AGC low threshold** (DPC\_AGC\_SHIFT\_VALUE)

Details refer to section 1.2.5.

4. **AGC high threshold per gear** (DPC\_THRSH\_HIGH)

Details refer to 1.2.4.

An easy way to calibrate the DPC is provided by the NFC Cockpit.

**3.3 Calibration procedure with the NFC Cockpit**

The DPC calibration is started with the NFC Cockpit as shown in Fig 16. The EEPROM LUT might be cleared (overwritten with 00), just to get clean table.

**Note:** The PN5180 NFC Cockpit allows to store the complete PN5180 EEPROM content into an XML file, and later reload this XML file back into the PN5180. It might be a good idea to save the EEPROM content as backup before changing the EEPROM.

**Note:** The PN7462 NFC Cockpit allows a storage of the DPC EEPROM settings into an XML or Binary file. The XML might be used for documentation purpose, while the binary can be directly loaded into the PN7462, using the NFC Cockpit or PN7462 “USB mass storage” mode. It might be good to save EEPROM content as backup before changing the EEPROM.

The number of gears must be entered as shown in Fig 16. This automatically generates the table below with the given number of entries (one per gear).

(1) The gear table starts with gear 0 in the first row (up to gear 4), even though the NFC Cockpit shows a number 1 (up to 5).

**Fig 16. DPC Calibration Step 1**

In the next step the maximum allowed ITVDD must be entered as shown in Fig 17.



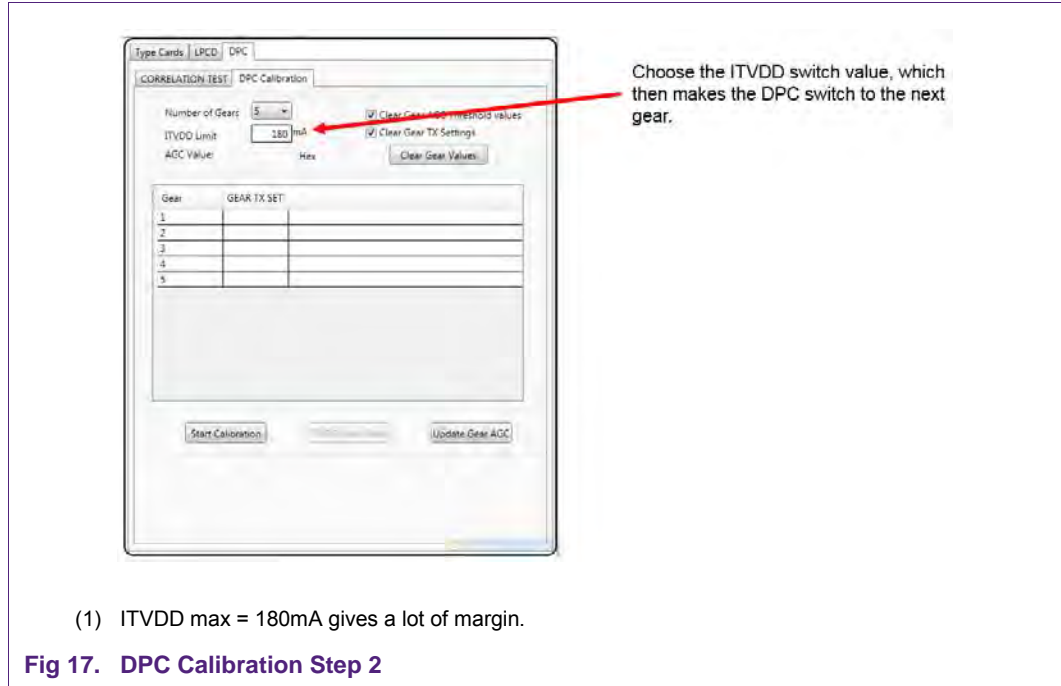

Then the Tx settings per gear must be entered, as shown in Fig 18. The settings can be chosen as described in section 1.2.3.

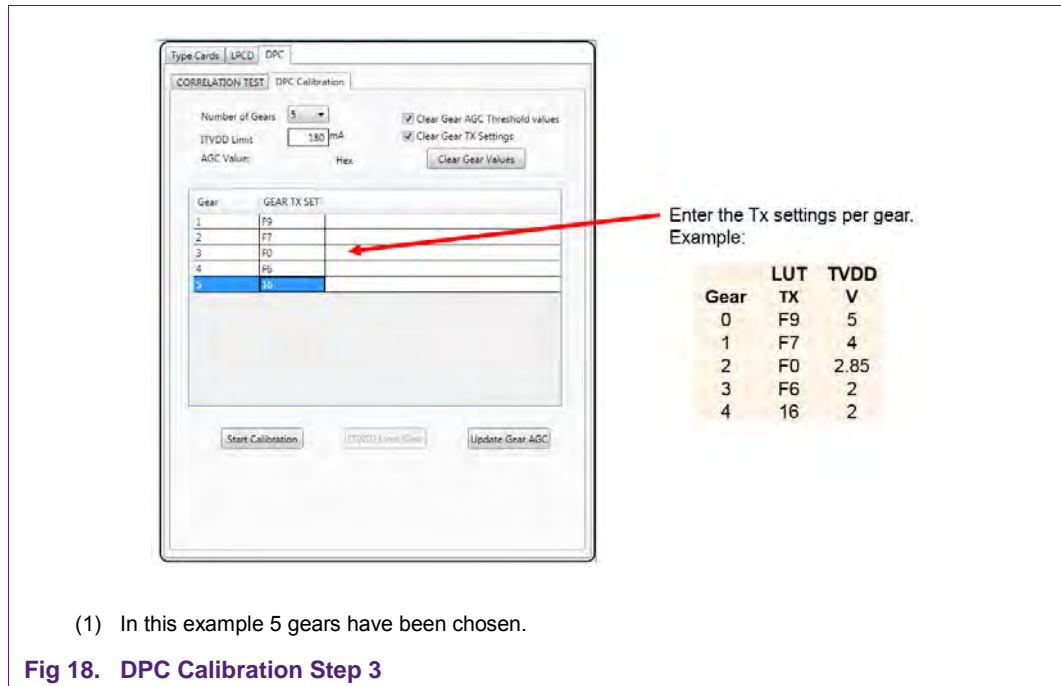

Then the calibration itself can be started. The ITVDD must be measured like in section 3. In the first step the NFC Cockpit starts with the gear 0, i.e. with maximum output power. The load must be adapted, until the ITVDD reaches the chosen ITVDD limit. Normally

that means the operating distance of the Reference PICC (used as load) is decreased, until the Ampere meter indicates the ITVDD limit value.

The screenshot shows the 'DPC Calibration' window. At the top, there are tabs for 'Type Cards', 'LPCD', and 'DPC'. Below that, a 'CORRELATION TEST' section contains a 'DPC Calibration' sub-section. It features a 'Number of Gears' dropdown set to '5', an 'ITVDD Limit' input field set to '180 mA', and an 'AGC Value' input field. There are checkboxes for 'Clear Gear AGC Threshold values' and 'Clear Gear TX Settings', and a 'Clear Gear Values' button. A table lists gears with their corresponding 'GEAR TX.SET' values:

Gear	GEAR TX.SET
1	F9
2	F7
3	F0
4	F6
5	16

At the bottom of the window are three buttons: 'Start Calibration', 'ITVDD Limit Gear', and 'Update Gear AGC'. To the right of the main window, three numbered instructions are listed:

- 1) Start Calibration.
- 2) Change load, until the ITVDD reaches ITVDD limit (180mA in this case).
- 3) Take AGC threshold value

A yellow arrow points from the third instruction to an 'Information' dialog box. The dialog box contains the following text:

```

Information
-----
Gear with TxSettings = 0xF9
Gear AGCValue =318
ITVDD Limit value = 180
    
```

Below the dialog box is an 'OK' button.

(1) This example uses the AGC values due to the higher Rx resistor (5.1kΩ), which results in an unloaded AGC value of 243. Refer to 7 for details.

**Fig 19. DPC Calibration start with gear 0**

Then the button <ITVDD Limit Gear> must be pressed. The NFC Cockpit then shows the corresponding information in a window:

Gear Tx settings (of gear 0 as given by the table entry), the measured AGC value and the corresponding ITVDD (adjusted with the load).

This AGC value now is (pre-) stored as AGC Threshold value for the gear 0, i.e. the PN5180 (resp. PN7462) will later switch to gear 1, as soon as the AGC value exceeds this AGC Threshold.

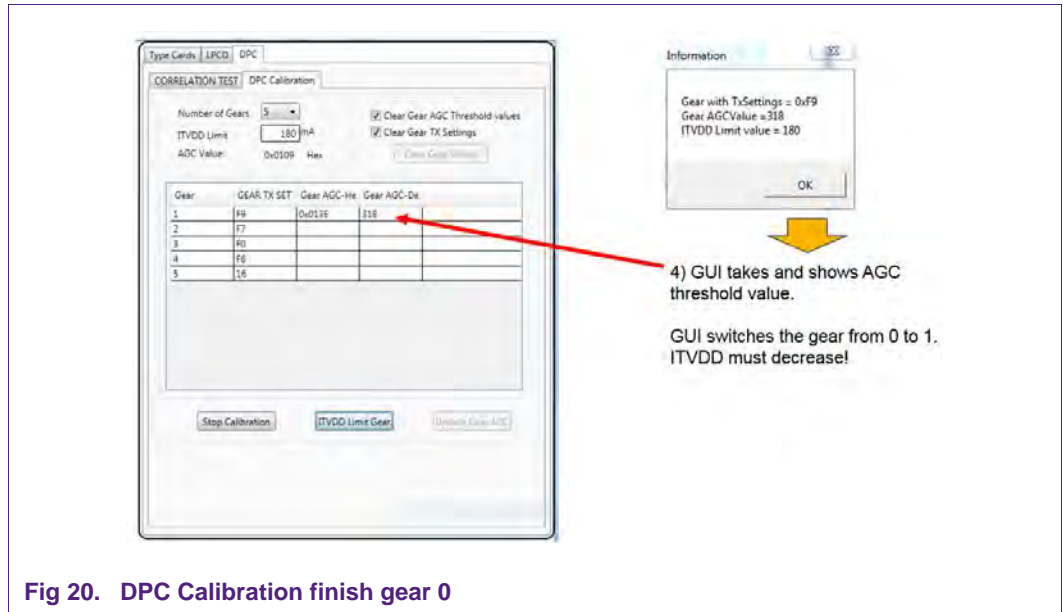

Fig 20. DPC Calibration finish gear 0

Then the NFC Cockpit automatically switches to the next gear (gear 1), which reduces the ITVDD (and the AGC value).

Again the load must be adapted now, until the ITVDD Limit is reached, i.e. the operating distance of the load must be decreased. When the Ampere meter indicates the ITVDD limit, again the button <ITVDD Limit Gear> must be pressed.

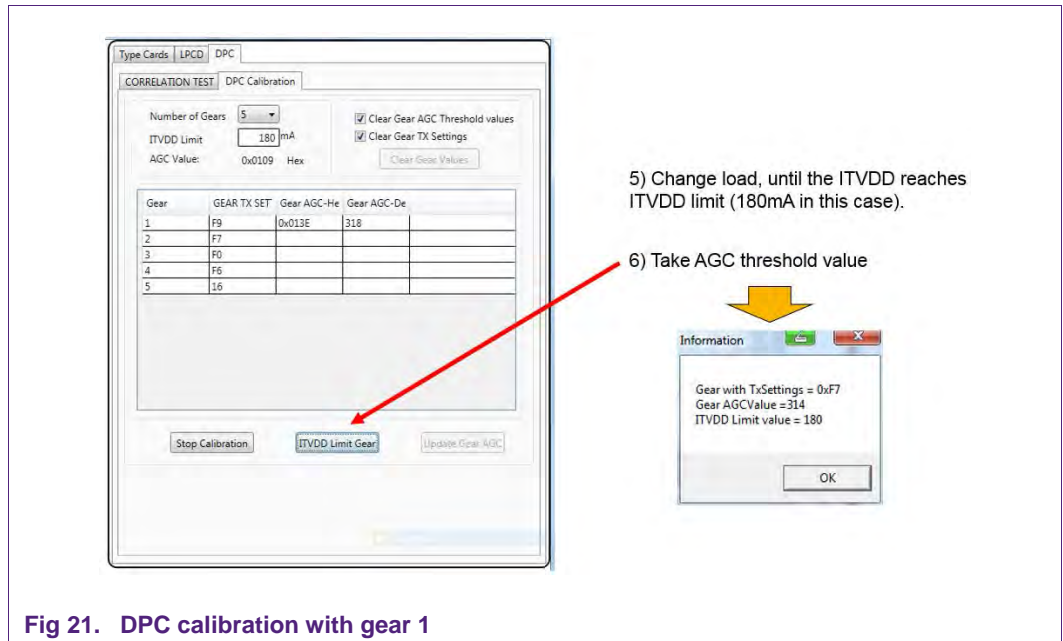

Fig 21. DPC calibration with gear 1

Now the NFC Cockpit shows the Gear Tx settings (of gear 1 as given by the table entry), the measured AGC value and the corresponding ITVDD (adjusted with the load).

This process must be continued gear by gear:

1. The NFC Cockpit switches to the next gear.
2. The load must be adapted until the ITVDD (Ampere meter) reaches the ITVDD limit.
3. The <ITVDD Limit Gear> (pre-) stores the AGC Threshold value for the corresponding gear.

When the calibration is done, the AGC Threshold values are (pre-) stored in a table as shown in Fig 22.

Pressing the <Update Gear AGC> stores the whole table into the EEPROM. Now the DPC calibration is done.

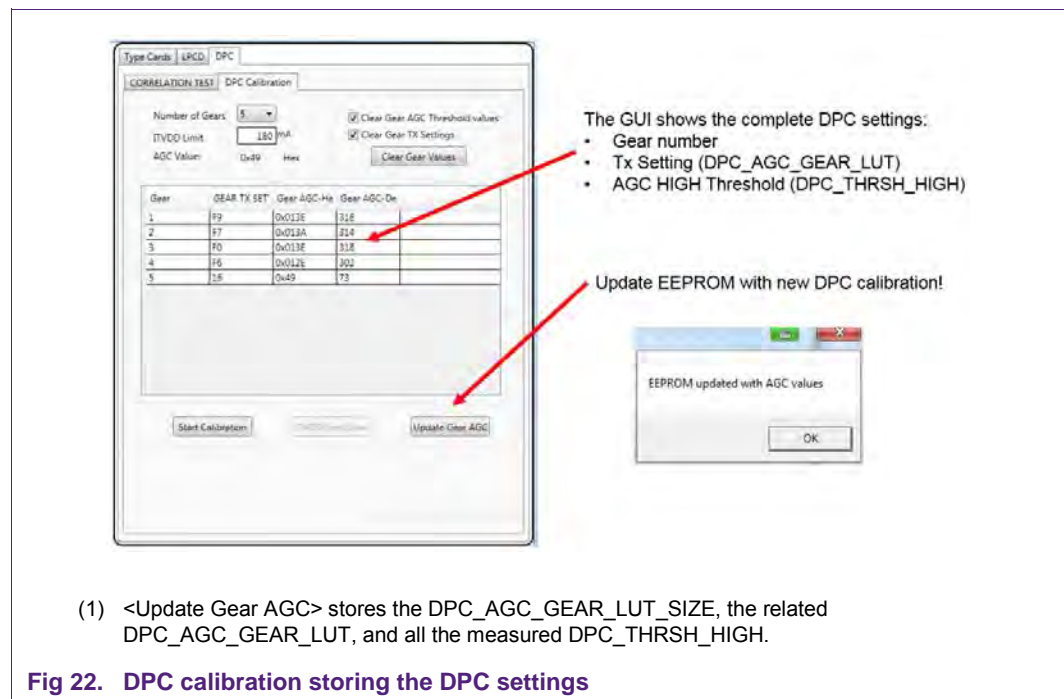

## 4. Tx Shaping

The influence of the EMC filter circuit as well as the TX output itself on the overall antenna behavior is quite strong with the DPC antenna tuning. This allows to use a higher Q factor in the antenna circuit itself, but requires a careful EMC filter design and a Tx Shaping control.

The EMC filter must use inductors with a high Q to achieve a fast fall and rise of the envelope. The higher the Q factor of the EMC filter is, the shorter becomes the fall and rise time of the envelope.

Due to this short fall and rise time in a typical DPC antenna design there are overshoots on both the falling and the rising edge of the envelope as shown in Fig 23. This can be corrected with the TX Shaping features of the PN5180 (resp. PN7462), as described in the following section.

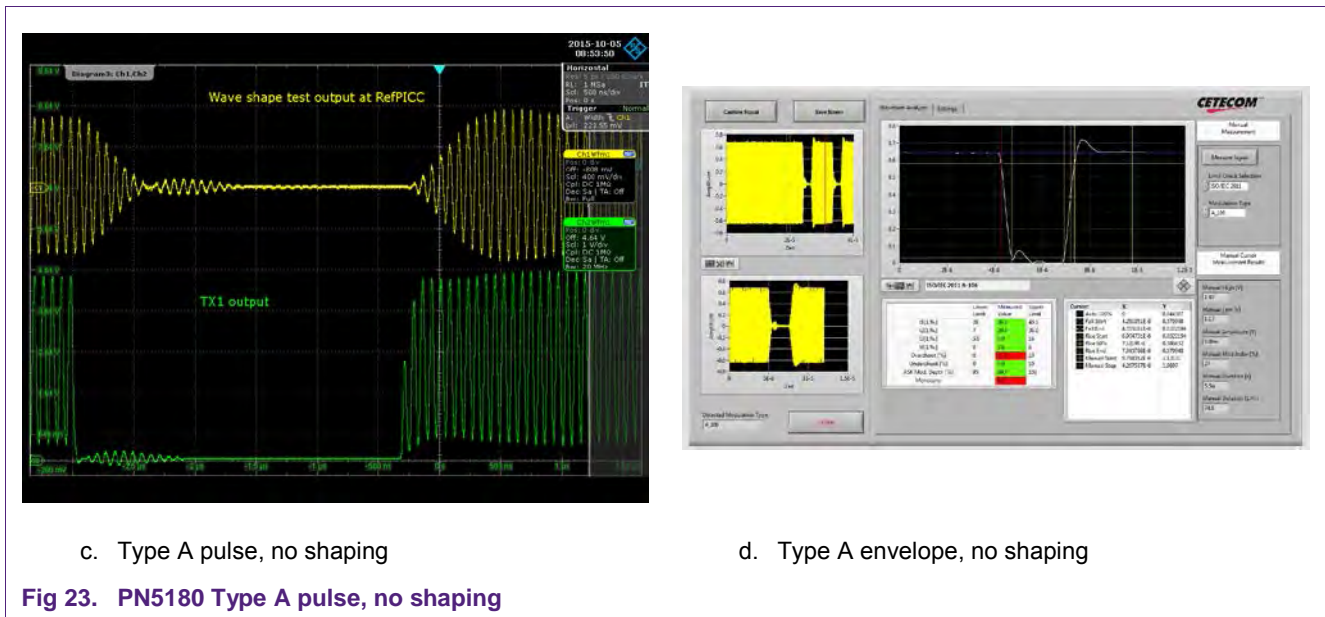

### 4.1 Tx Shaping principle

Instead of switching on and off the carrier (@ 100%AM) or switching between two different carrier levels (e.g. @ 10%AM), the PN5180 (resp. PN7462) allows to control the change from unmodulated carrier to modulated carrier and again from modulated carrier to unmodulated carrier.

So basically a standard pulse, like a type A pulse as shown in Fig 24a, is extended from 2 to 4 states:



1. Unmodulated carrier (= CW)
2. Undershoot pattern (= falling edge)
3. Modulated carrier (e.g. carrier off or 10% settings)
4. SC Shaping (= rising edge)

These four states are shown in an example in Fig 24b. Within the two “transition” states several parameters can be set to define the falling edge and rising edge behavior.

In principle the transition state length can be defined (see Fig 24b), the rise and fall time (Fig 25a) and the residual carrier in case of the 100% AM (Fig 25b).

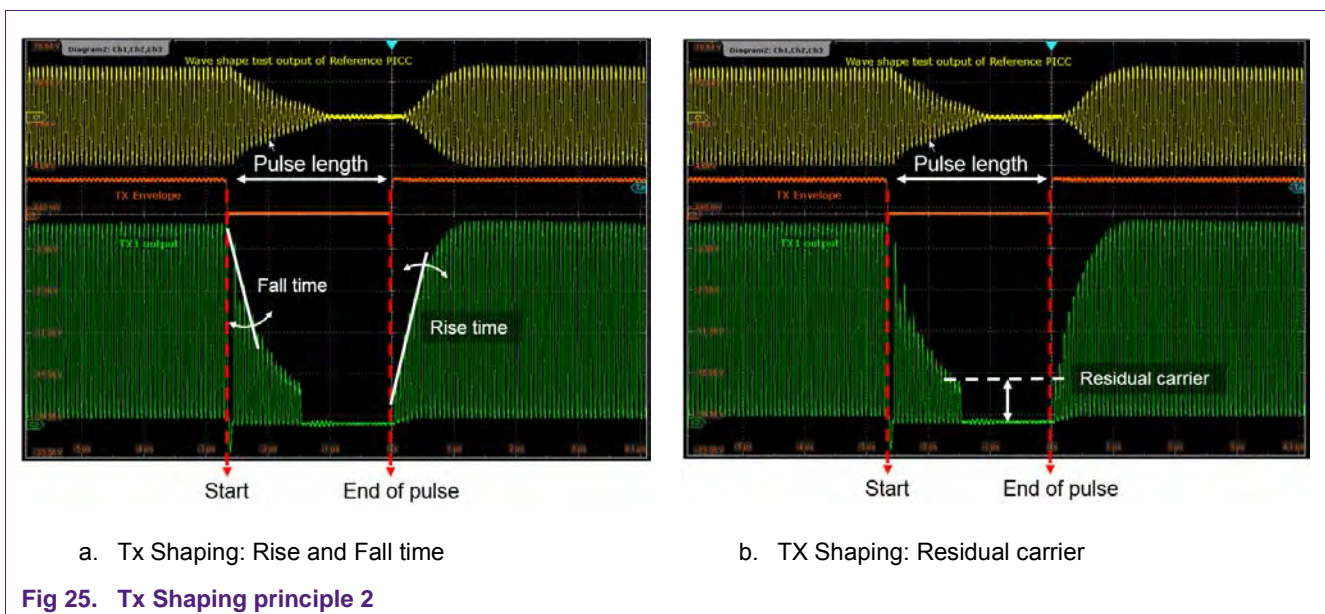
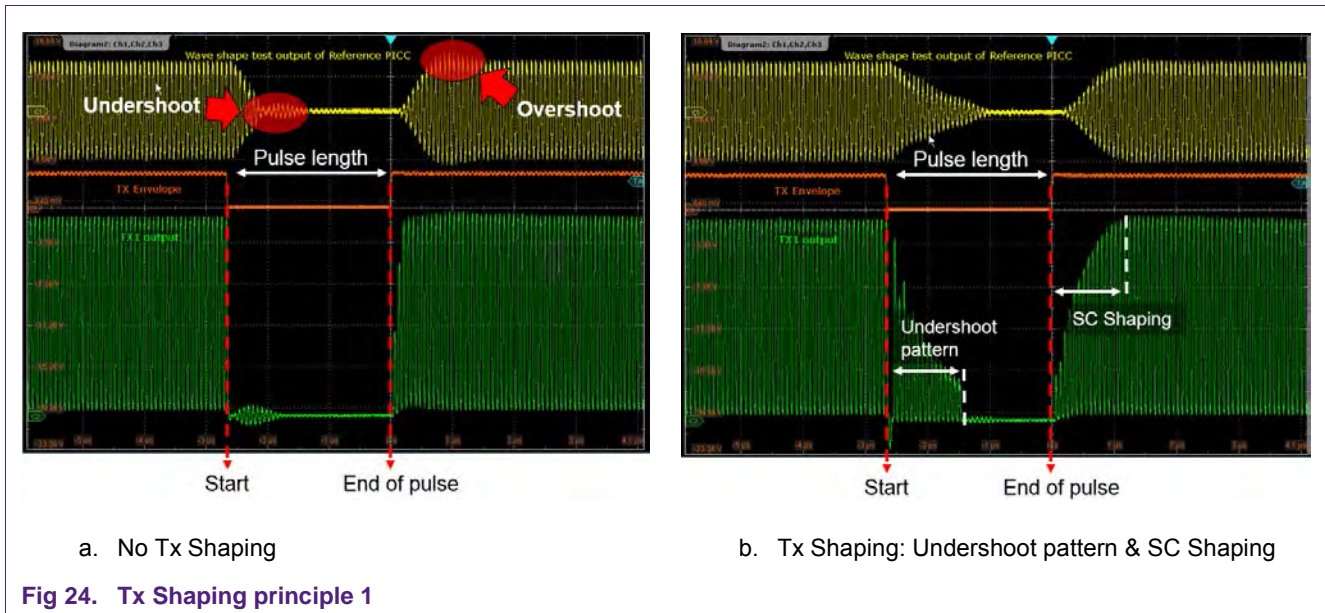

Three parameters can even be dynamically adapted based on the DPC using the AWC:

- Fall time
- Rise time

- Residual carrier

**Note:** The residual carrier sets the modulation index as such, if no 100% AM is enabled (e.g. for ISO/IEC 14443 type B). In case of 100% AM it only sets the residual carrier for the transition phase.

#### 4.2 Wave shape test set up

The wave shape tests require a Reference PICC to load the PN5180 (resp. PN7462) antenna properly while testing the wave shapes. The wave shape test signal is derived from the Reference PICC, as defined in ISO/IEC 10373-6 or EMVCo Book D or NFC Forum Specifications.

For the optimization of the shaping it might be helpful to connect a probe of the oscilloscope to one of the TX output pins of the PN5180 (resp. PN7462). The principle of the whole setup is shown in Fig 26.

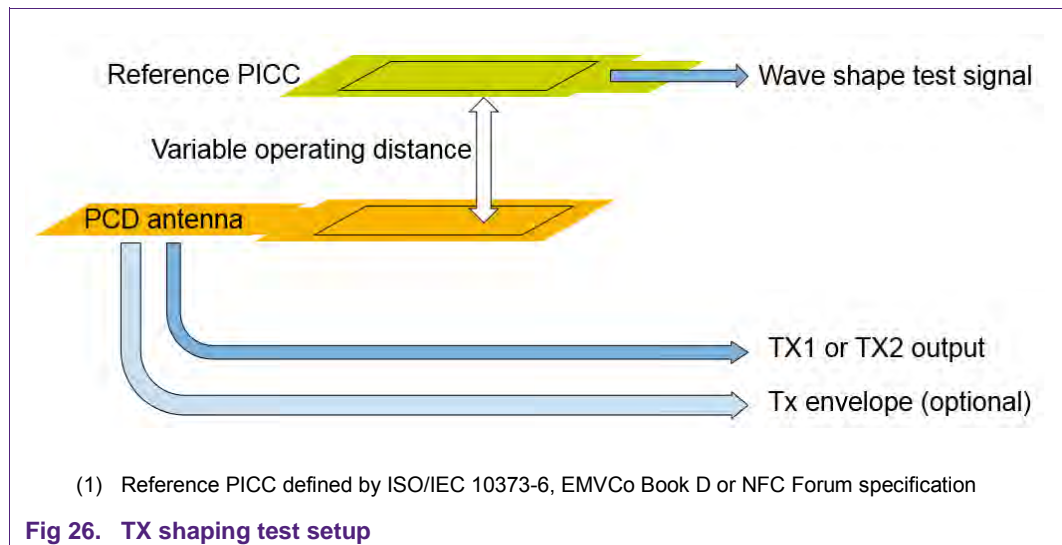

**Note:** This probe connected to TX1 or TX2 slightly disturbs the wave shape itself, so the final compliance test must be done without this probe connection.

The wave shape test should be started with the maximum possible operating distance, i.e. with the minimum loading effect. For EMVCo this is at 4cm distance, for any ISO/IEC 14443 test it is at the minimum field strength limit (e.g. at 1.5A/m for Class1).

This automatically results in a gear 0 setting, i.e. the PN5180 (resp. PN7462) drives the maximum output power. The typical envelope looks like shown in Fig 23, as long as neither the undershoot / overshoot protection nor the TX Shaping is enabled.

**Note:** The measurement of the TX output is done with a digital low pass filter with a cut off frequency of 30MHz. This reduces the noise level and removes any possible spikes on the tested signal.

### 4.3 Differences PN5180 versus PN7462

The DPC as well the TX Shaping functionality is the same on PN5180 and on PN7462. Still some small details related to the memory structure are different. The PN5180 offers “virtual registers”, which allow a very consistent handling.

The PN7462 needs to deal with the original CLIF registers.

Therefore in both cases the same functionality can be found in slightly different registers.

#### 4.3.1 PN5180 relevant registers

The PN5180 provides four Tx Shaping related registers, of which three registers are relevant:

##### **TX UNDERSHOOT CONFIG (0x0014)**

- TX UNDERSHOOT\_PATTERN: don't touch
- TX UNDERSHOOT\_PATTERN\_LEN: important
- TX UNDERSHOOT\_PROT\_ENABLE: should be 1

##### TX\_OVERSHOOT\_CONFIG (0x0015)

- TX\_OVERSHOOT\_PATTERN: don't touch
- TX\_OVERSHOOT\_PATTERN\_LEN: not important!
- TX\_OVERSHOOT\_PROT\_ENABLE: should be 0!

##### **RF CONTROL\_TX (0x0020)**

- TX\_RESIDUAL\_CARRIER\_OV\_PREV: not important, if TX\_OVERSHOOT\_PROT\_ENABLE = 0
- TX\_RESIDUAL\_CARRIER: a low residual carrier might be good
- TX\_SET\_BYPASS\_SC\_SHAPING: should be 0 to allow SC Shaping
- TX\_SET\_SLEW\_SHUNTREG: don't touch
- TX\_SET\_TAU\_MOD\_FALLING: important!
- TX\_SET\_TAU\_MOD\_RISING: important!

##### **RF CONTROL\_TX\_CLK (0x0021)**

- TX\_CLK\_MODE\_OVUN\_PREV: Type A: use 101 instead 111 to slow down the falling edge
- TX\_CLK\_MODE\_RM: for type A it is typically 001, for type B it must be 111

#### 4.3.2 PN7462 relevant registers

The PN7562 provides four Tx Shaping related registers, of which three registers are relevant:

##### **CLIF\_TX UNDERSHOOT CONFIG REG (address 0058h)**

- TX\_UNDERSHOOT\_PATTERN: don't touch
- TX\_UNDERSHOOT\_PATTERN\_LEN: important
- TX\_UNDERSHOOT\_PROT\_ENABLE: should be 1

CLIF\_TX\_OVERSHOOT\_CONFIG\_REG register (address 0054h)



- `TX_OVERSHOOT_PATTERN`: don't touch
- `TX_OVERSHOOT_PATTERN_LEN`: not important!
- `TX_OVERSHOOT_PROT_ENABLE`: should be 0!

#### **CLIF ANA TX SHAPE CONTROL REG (address 0128h)**

- `TX_RESIDUAL_CARRIER_OV_PREV`: not important, if `TX_OVERSHOOT_PROT_ENABLE = 0`
- `TX_SET_BYPASS_SC_SHAPING`: should be 0 to allow SC Shaping
- `TX_SET_SLEW_SHUNTREG`: don't touch
- `TX_SET_TAU_MOD_FALLING`: important!
- `TX_SET_TAU_MOD_RISING`: important!

#### **CLIF ANA TX AMPLITUDE REG (address 0108h)**

- `TX_RESIDUAL_CARRIER`: low residual carrier might be good

#### **CLIF ANA TX CLK CONTROL REG (address 0104h)**

- `TX_CLK_MODE_OVUN_PREV`: Type A: use 101 instead 111 to slow down the falling edge
- `TX_CLK_MODE_RM`: for type A it is typically 001, for type B it must be 111

## 4.4 PN5180 and PN7462 relevant settings

So independent from the bit position the relevant bit fields for the Tx Shaping are the following 8 settings.

### 4.4.1.1 TX\_UNDERSHOOT\_PROT\_ENABLE

This bit enables the `UNDERSHOOT_PATTERN`, applying the `TX_UNDERSHOOT_PATTERN_LEN`. So it should be enabled to allow the shaping features for the falling edge.

See Fig 27 for example.

### 4.4.1.2 TX\_UNDERSHOOT\_PATTERN\_LEN

Defines length of the undershoot prevention pattern (value +1). This is one of the key parameters to adjust (reduce) the undershoot, especially for the type A modulation.

See Fig 27 for example.

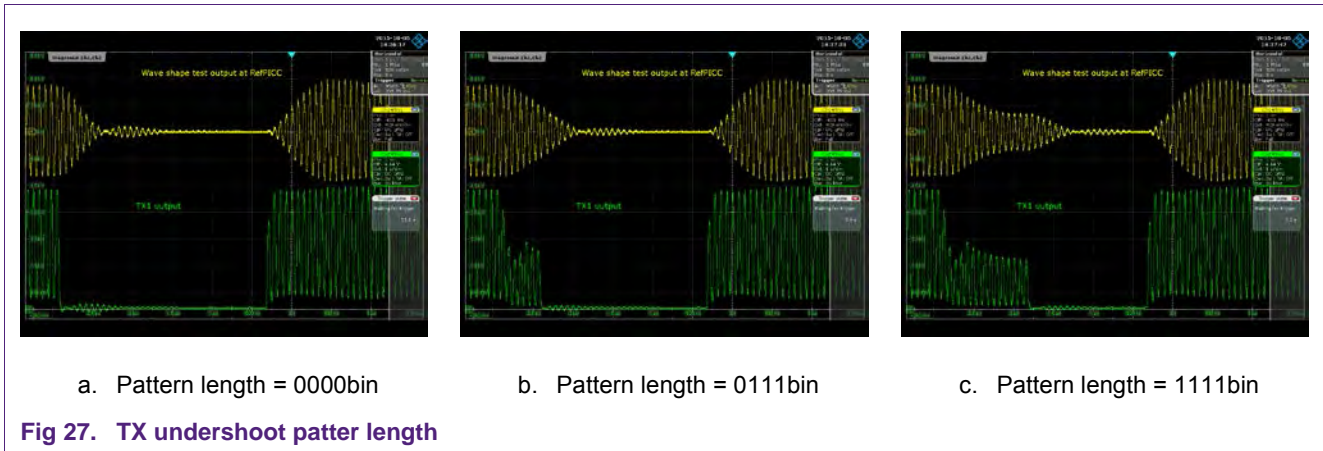

#### 4.4.2 TX\_UNDERSHOOT\_PATTERN

The undershoot pattern coding can be changed, but other patterns than the default (all 0) are typically not useful. Refer to Fig 26.

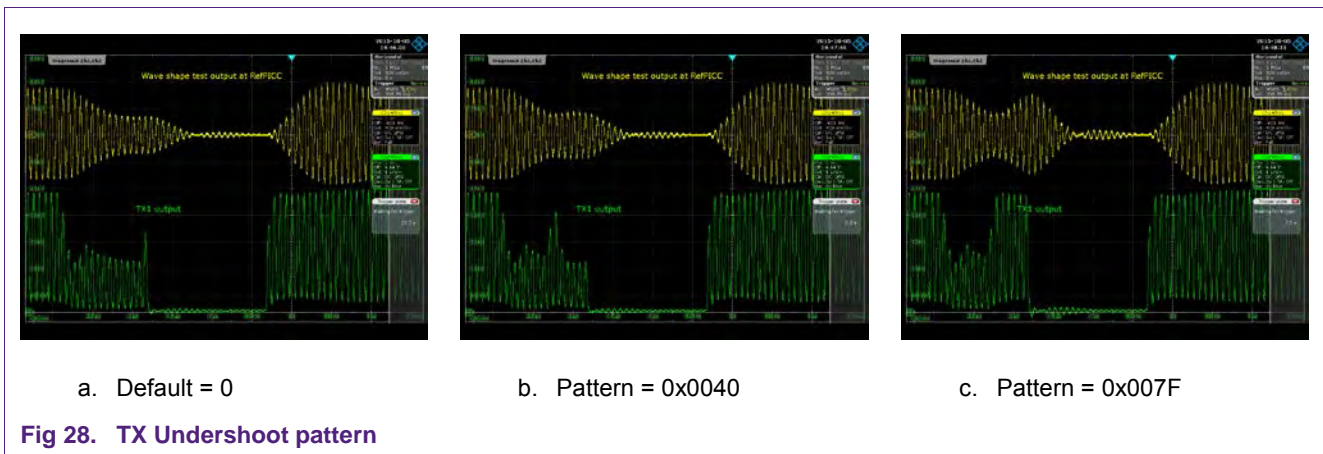

##### 4.4.2.1 TX\_RESIDUAL\_CARRIER

These 7 bit defines the modulation index via the residual carrier:

0 => m = 100%

0x1F => m = 0%

This value is especially relevant for type B modulation.

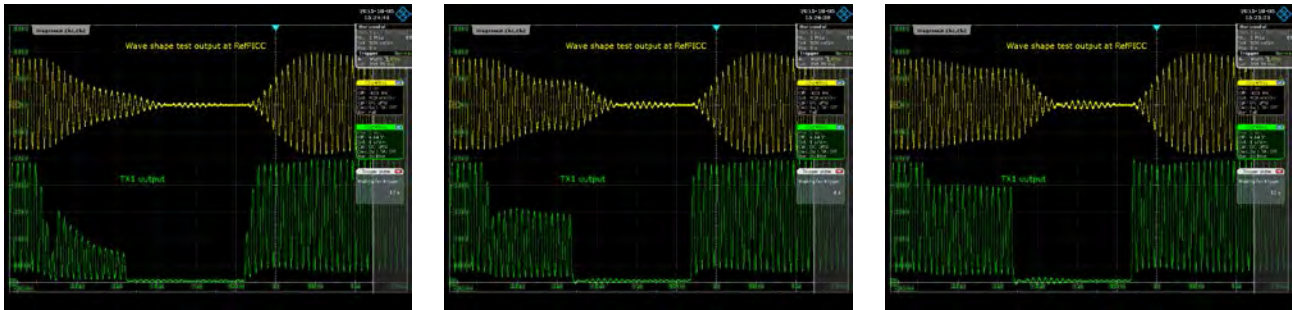

a. Residual carrier = 11111bin

b. Residual carrier = 11001bin

c. Residual carrier = 01111bin

**Fig 29. TX undershoot residual carrier**

The Fig 30 shows the effect of the TX Residual carrier level, if the TX\_CLK\_MODE\_OVUN\_PREV = 101bin (i.e. the residual carrier only applies on the rising edge).

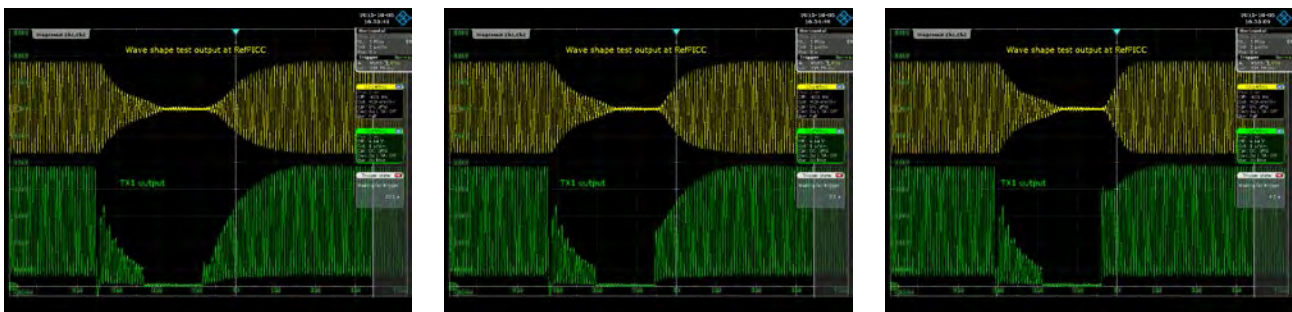

a. Residual carrier = 11111bin

b. Residual carrier = 11011bin

c. Residual carrier = 10011bin

**Fig 30. TX Overshoot Residual carrier**

**4.4.2.2 TX\_SET\_BYPASS\_SC\_SHAPING**

Enabling this bit bypasses the “Switched Capacitor” Tx shaping, i.e. disables the shaping control for the rising edge. So this bit must be 0, if the TAU\_MOD\_RISING settings shall apply.

The rising edge provides the fastest rise time, if TX\_SET\_BYPASS\_SC\_SHAPING = 1 (TAU\_MOD\_RISING does not matter).

**4.4.2.3 TX\_SET\_TAU\_MOD\_FALLING**

This value defines the time constant for the falling edge.

0 => fastest fall time, typically causing a large undershoot

0xF => slowest fall time, typically causing a small undershoot

This parameter is typically used to balance the undershoot requirement with the fall time requirement, and can be dynamically adapted per gear with the AWC.

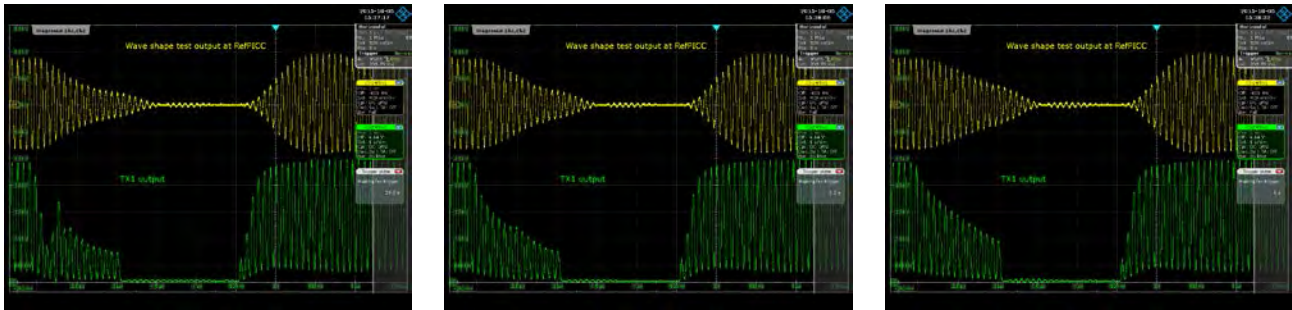

a. Tau Mod Falling = 0000bin

b. Tau Mod Falling = 1000bin

c. Tau Mod Falling = 1111bin

Fig 31. TX undershoot Fall time behavior

#### 4.4.2.4 TX\_SET\_TAU\_MOD\_RISING

This value defines the time constant for the rising edge.

0 => fastest rise time, typically causing a large overshoot

0xF => slowest rise time, typically causing a small overshoot

This parameter is typically used to balance the overshoot requirement with the rise time requirement, and can be dynamically adapted per gear with the AWC.

See Fig 32 for example.

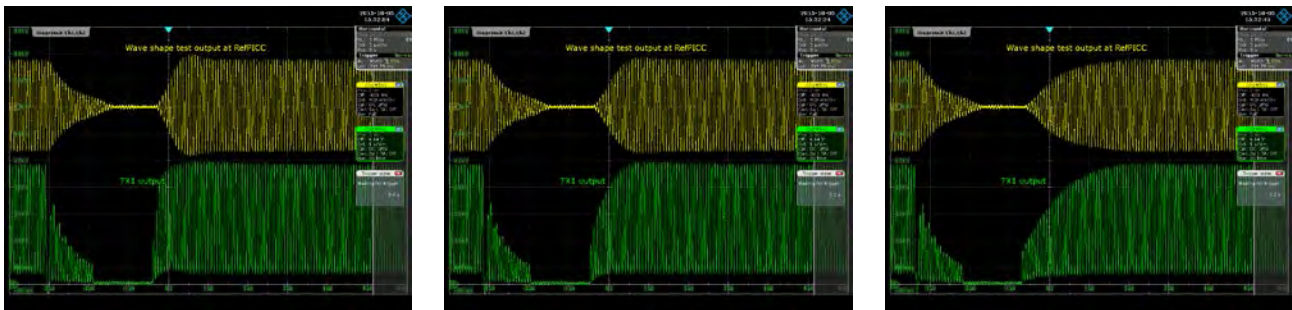

a. Tau Mod Rising = 0000bin

b. Tau Mod Rising = 0100bin

c. Tau Mod Rising = 1111bin

Fig 32. TX overshoot Rise time behavior

#### 4.4.2.5 TX\_CLK\_MODE\_OVUN\_PREV

The TX\_CLK\_MODE\_OVUN\_PREV defines the TX Clock mode setting for the pattern in the transition states. There are two most useful settings:

- The **default setting = 111bin** drives the pattern using the push/pull output like during the unmodulated carrier (or like during the modulation for type B)



- The setting = 101bin only drives the low side of the push/pull output stage (“open drain”), which disables the residual carrier settings, but slows down the carrier during the pattern length.

**Note:** The TX\_CLK\_MODE\_OVUN\_PREV = 101bin typically provides the smoothest falling edge for a type A pulse, but does not allow any dynamic adaptation in the AWC, since the TX\_SET\_TAU\_MOD\_FALLING does not apply in this case.

## 4.5 Remove undershoot

Normally the first step in the Tx Shaping adjustment is the reduction of the undershoot in the falling edge of the pulse. Especially for the 100% pulse of type A this undershoot might cause a violation of the ISO or EMVCo shaping requirements.

The undershoot protection must be enabled with TX\_UNDERSHOOT\_PROT\_ENABLE (bit 0).

The undershoot protection pattern and behavior can be defined with:

- **Pattern length:** the pattern length changes the length of the undershoot pattern from 0000bin to 1111bin (0x0 to 0xF), refer to Fig 27. Typically a pattern length around 3 to 5 turned out to be useful.
- **Pattern coding:** the default pattern is 0. Other patterns are typically not useful, but can be set, refer to Fig 28.
- **TX Clock mode:** The TX\_CLK\_MODE\_OVUN\_PREV defines the TX Clock mode setting for the pattern. There are two most useful settings:
  - The default setting = 111bin drives the pattern using the push/pull output like during the unmodulated carrier (or like during the modulation for type B)
  - The setting = 101bin only drives the low side of the push/pull output stage (“open drain”), which disables the residual carrier settings, but slows down the carrier during the pattern length.
- **Residual carrier:** the TX\_RESIDUAL\_CARRIER defines the carrier level at the end of the undershoot pattern, if the TX Clock mode is set to 111bin.

This carrier level applies also at the end of the pulse, when the pulse rising edge starts: Therefore the residual carrier setting influences the overshoot (TX Shaping) behavior, too (refer to section 4.4.2.1).

The TX\_RESIDUAL\_CARRIER is used to set the residual carrier for Type B, too.

Fig 29 shows three different settings:

- The minimum residual carrier with 0x1F (Fig 29a)
- A residual carrier with 0x19 (Fig 29b)
- A residual carrier with 0x0F (Fig 29c)
- **Fall time behavior:** The TAU\_MOD\_FALLING defines the fall time behavior, if the TX Clock mode is set to 111bin and the SC Shaping is enabled. The Fig 31 shows three different fall times from minimum (0x0) to maximum (0xF).

**Note:** The TX\_RESIDUAL\_CARRIER\_OV\_PREV applies only during the overshoot prevention and is typically not used at all.

**Note:** For a type A pulse the TX Clock mode setting = 101bin allows to use a “low residual carrier” to reduce the undershoot at the beginning of the pulse, independent from the residual carrier settings. The residual carrier level then does only influence the overshoot behavior, and can be adjusted more flexibly.

## 4.6 Remove overshoot

The use of TX overshoot protection is not recommended. The bit 0 (TX\_OVERSHOOT\_PROT\_ENABLE) should be set to 0.

With the TX Shaping the overshoot at the end of the pulse can be reduced. The TX SC Shaping can be enabled with the bit TX\_BYPASS\_SC\_SHAPING, which must be set to 0 (= disable the bypass!).

The overshoot protection pattern and behavior can be defined with:

- **Rise time behavior:** the TAU\_MOD\_RISING can be used to increase the rise time, which then decreases the overshoot. The Fig 32 shows three different settings from minimum (0x0) to maximum (0xF).
- **Residual carrier:** the TX\_RESIDUAL\_CARRIER defines the carrier level at the end of the pulse, when the rise time of the pulse starts. This is independent from the TX Clock mode setting.

This carrier level applies to the beginning of the pulse, too, if the TX Clock Mode = 111bin: therefore the residual carrier setting influences the undershoot behavior, too (refer to section 4.5).

The TX\_RESIDUAL\_CARRIER is used to set the residual carrier for Type B, too.

Fig 30 shows three different settings:

- The minimum residual carrier with 0x1F (Fig 30a)
- A residual carrier with 0x1B (Fig 30b)
- A residual carrier with 0x03 (Fig 30c)

4.7 Examples

The TX Shaping examples are shown for a 2 turn antenna as indicated in Fig 33.

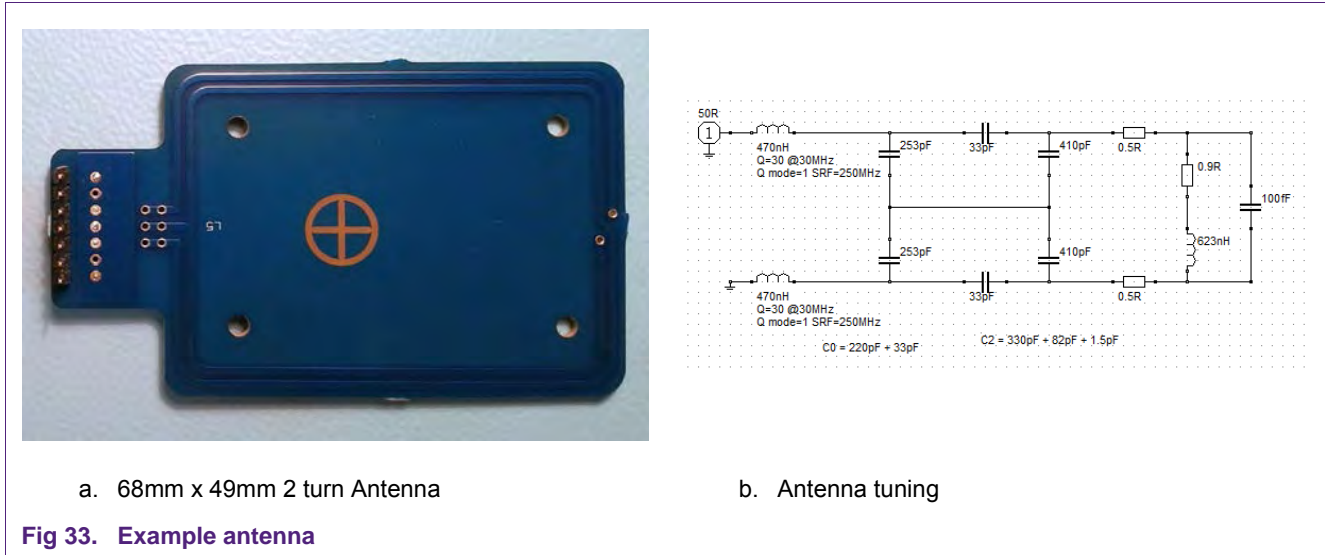

4.7.1 Example of a TX shaping setting for type A

The Fig 34 shows the standard type A pulse of the example antenna without any TX Shaping. Basically the envelope test of EMVCo fails due to the overshoots.

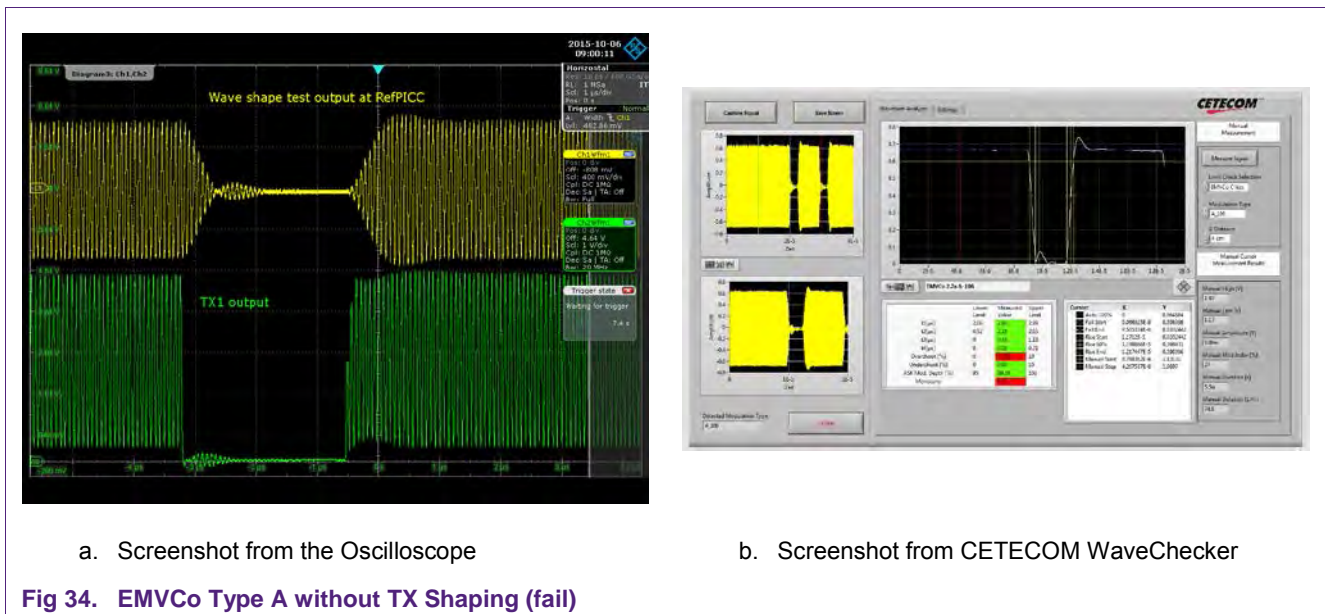

The Fig 35 shows the same antenna, but with enabled TX Shaping, using undershoot protection and TX SC Shaping with the following register settings:

Table 7. EMVCo Type A with TX Shaping

Setting	Value (bin)	Comment
TX_UNDERSHOOT_PATTERN_LEN	1111	
TX_UNDERSHOOT_PROT_ENABLE	1	Undershoot protection enabled
TX_RESIDUAL_CARRIER	11110	
TX_SET_BYPASS_SC_SHAPING	0	SC Shaping enabled
TX_SET_TAU_MOD_FALLING	0100	
TX_SET_TAU_MOD_RISING	0011	
TX_CLK_MODE_OVUN_PREV	101	Only low side of the push/pull output stage
TX_CLK_MODE_RM	001	Due to type A 100% AM

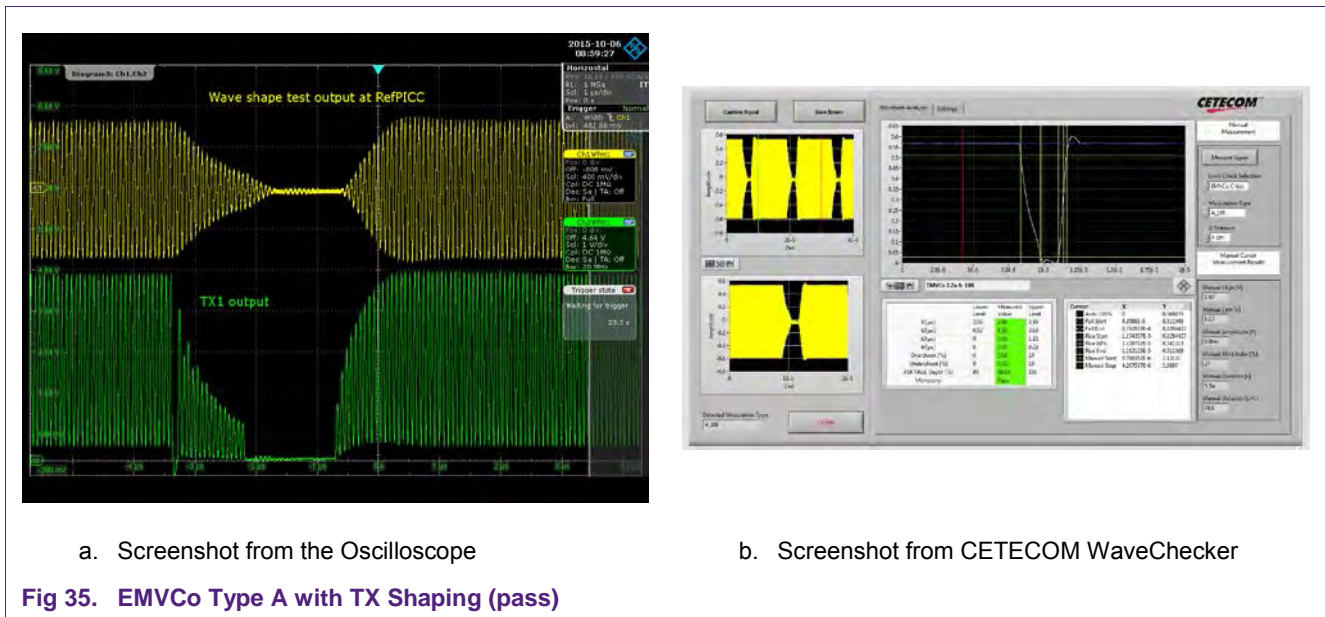

These register settings must then be stored in the EEPROM in the corresponding Protocol area. The NFC Cockpit supports writing the register into the correct position by selecting the protocol, e.g. “TX IOS14443A 106” indicating the area of the transmitter settings for ISO/IEC 14443 type A protocol at 106 kbit/s.



4.7.2 Example of a TX shaping setting for type B

The Fig 36 shows the standard type A pulse of the example antenna without any TX Shaping. Basically the envelope test of EMVCo fails due to the overshoots.

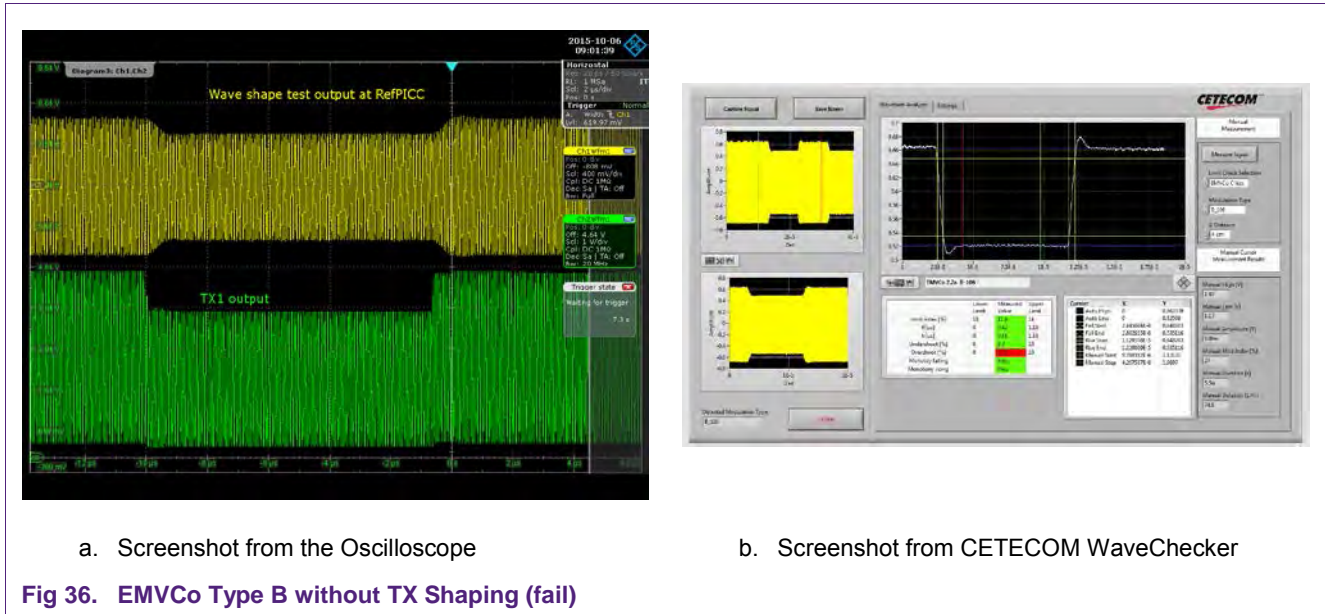

The Fig 37 shows the same antenna, but with enabled TX Shaping, using TX SC Shaping with the following register settings:

**Table 8. EMVCo Type B with TX Shaping**

Setting	Value (bin)	Comment
TX_UNDERSHOOT_PATTERN_LEN	0000	
TX_UNDERSHOOT_PROT_ENABLE	0	Undershoot protection disabled
TX_RESIDUAL_CARRIER	11110	
TX_SET_BYPASS_SC_SHAPING	0	SC Shaping enabled
TX_SET_TAU_MOD_FALLING	0001	
TX_SET_TAU_MOD_RISING	0110	To slow down the rising edge
TX_CLK_MODE_OVUN_PREV	000	Does not matter, since undershoot protection is disabled.
TX_CLK_MODE_RM	111	Due to type B 10% AM

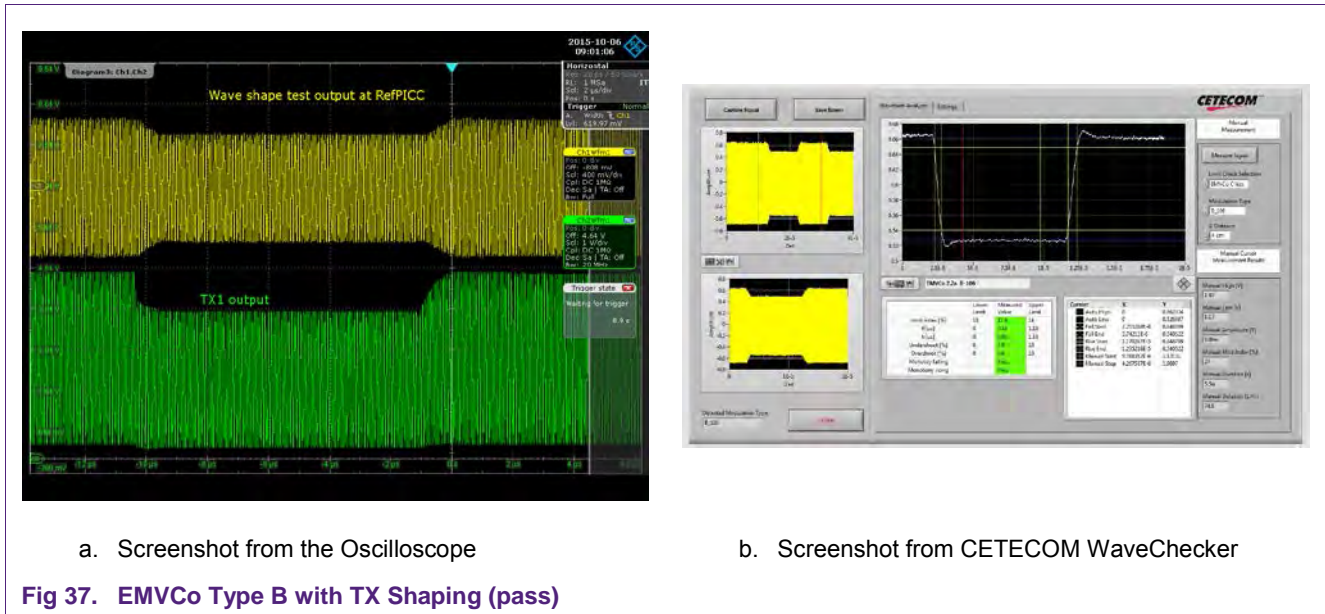

These register settings must then be stored in the EEPROM in the corresponding Protocol area. The NFC Cockpit supports writing the register into the correct position by selecting the protocol, e.g. “TX IOS14443B 106” indicating the area of the transmitter settings for ISO/IEC 14443 type B protocol at 106 kbit/s.

#### 4.8 Tx Shaping per DPC gear per protocol (AWC)

With the load protocol the related TX Shaping settings are loaded for the gear 0, i.e. the gear with the maximum output power.

Reducing the output power with any higher gear can change the pulse shape behavior due to two reasons:

- First of all the different gear settings result in different driver behavior, which slightly can change the envelope.
- Secondly the loading as such, which causes the gear change, influences the envelope due to the detuning and loading of the antenna.

Therefore the PN5180 (resp. PN7462) allows to adapt the TX Shaping with three parameters per gear and per protocol:

4. TX\_TAU\_MOD\_FALLING
5. TX\_TAU\_MOD\_RISING
6. TX\_RESIDUAL\_CARRIER

These three parameters can be changed for a gear >0. The parameters are defined and stored as **delta values**, which apply to the defined gear and all higher gears. Each delta value defines the delta from the previous lower gear.

This feature is called Automatic Waveshape Control (AWC).

**4.8.1 Simple example of a delta value per gear**

An Example for one parameter and one protocol, using 5 gears is shown in Table 9. In this example the Load Protocol (e.g. for ISO/IEC 14443 type A @106) defines the TAUM\_MOD\_RISING to be 3.

**Table 9. Simple example of TX shaping per gear**  
 Load Protocol value of TX\_TAU\_MOD\_RISING = 3 (e.g. ISO14443 type A 106)  
 Delta value for gear 1 = -2  
 Delta value for gear 3 = -1

Gear #	Delta value	TX_TAU_MOD_RISING
0	- (n.a.)	3
1	-2	1
2	0	1
3	-1	0
4	0	0
5	0	0

Interpretation: Using these example values means the PN5180 (resp. PN7462) uses the TX\_TAU\_MOD\_RISING value of 3 for gear 0.

As soon as the PN5180 (resp. PN7462) switches from gear 0 to gear 1, it automatically reduces the TAU\_MOD\_RISING to 1.

Switching from gear 1 to gear 2 does not change the TAU\_MOD\_RISING, but switching from gear 2 to gear 3 makes the PN5180 (resp. PN7462) automatically reduce the TAU\_MOD\_RISING to 0. Switching to higher gears does not changes the value anymore, but switching back to 2 changes the TAU\_MOD\_RISING back to 1, and switching back to gear 0 makes the PN5180 (resp. PN7462) changing back to 3.

For this definition 2 entries are required.

**4.8.2 Entry table for the Tx Shaping per gear**

The EEPROM content is structured in a table of up to 16 entries, as shown in Table 10. Every entry must use a gear number equal or larger than the gear number of the previous entry, otherwise the entry will be ignored.

**Table 10. Entry table in the EEPROM**

Each entry contains 32 bit.

Entry #	Protocol bit mask Bit 31 ... 16	Residual carrier Bit 15 ... 12	TAU_MOD_RISING Bit 11 ... 8	TAU_MOD_FALLING Bit 7 ...4	Gear number Bit 3...0
1	Defines the protocol, which will be effected by the defined change.	Defines the change of the residual carrier. Range: -7 ... +7	Defines the rising edge of the pulse. Range: -7 .... +7	Defines the falling edge of the pulse. Range: -7 ... +7	Defines the gear number, which will be effected by the defined change.
2					
...					
16	Table 11.				

Each entry can define a set of delta values for all three parameters, and can link this set to a single gear and any protocol, as shown in Table 11.

Table 11. PCD Shaping entry definition

Each entry contains 32 bit.

bit #	Definition	
31 ... 29	RFU, don't use.	Must be 0.
28	180003m3	Enabling a protocol enables the defined PCD shaping setting changes, as defined in bit 15 ... 4 for the defined gear as defined in bit 3 ... 0. One or more protocols can be enabled.
27	15693 @ASK100%	
26	15693 @ASK10%	
25	NFC type F @424	
24	NFC type F @212	
23	14443 type B @848	
22	14443 type B @424	
21	14443 type B @212	
20	14443 type B @106	
19	14443 type A @848	
18	14443 type A @424	
17	14443 type A @212	
16	14443 type A @106	
15 ... 12	Residual carrier	
11 ... 8	TAU_MOD_RISING	Sign bit + 3 bit value
7 ... 4	TAU_MOD_FALLING	Sign bit + 3 bit value
3 ... 0	Gear number	Gear number 1 ... 14

The example of Table 9 requires 2 entries in the EEPROM: one for gear 1, another one for gear 3.

#### 4.9 AWC Tools for PN5180 and PN7462

Due to the different release plans of the two products the tool chain is not yet fully the same.

##### 4.9.1 AWC in the NFC Cockpit (PN5180)

In case of the PN5180 the NFC Cockpit supports the adjustment of the AWC, as shown in Fig 38. Refer to [4] for more details.

**Note:** The PN5180 FW 3.6 and higher provides a similar automatic adjustment of Rx settings per gear per protocol, which is not yet supported by the NFC Cockpit (2.4.7 or 2.4.10). The corresponding settings must be disabled to properly use the current NFC Cockpit properly, and then must be manually set afterwards.

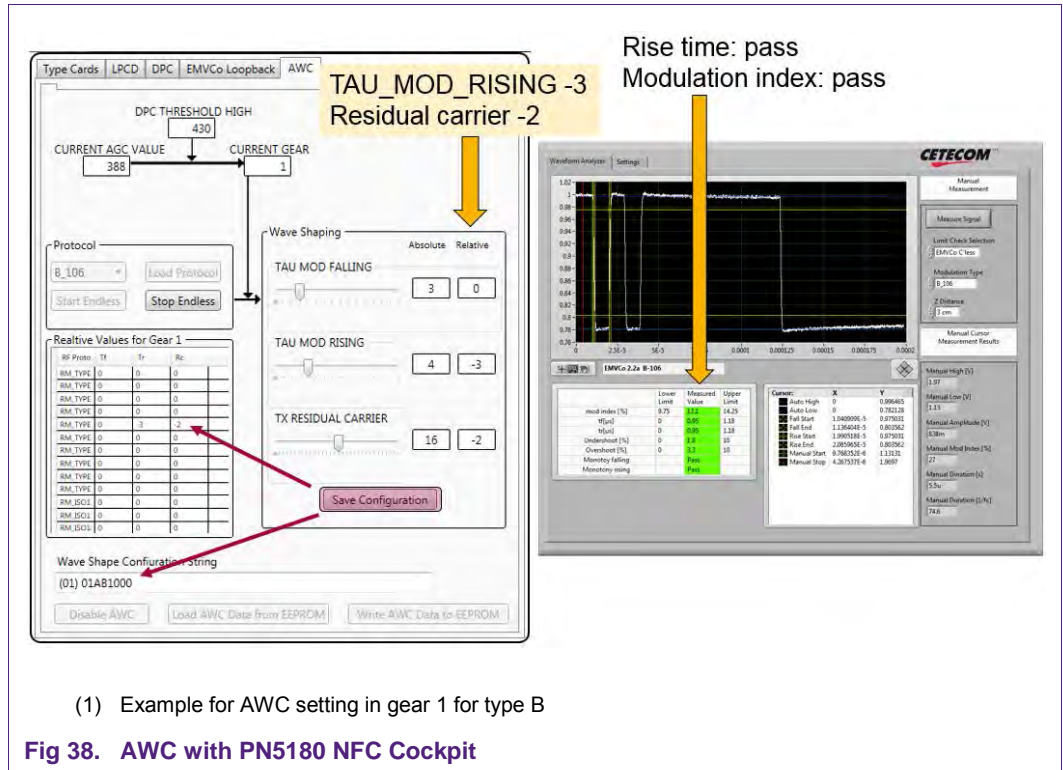

#### 4.9.2 AWC with Excel sheet (PN7462)

For the PN7462 there is a configuration tool (Excel sheet) available, which generates the EEPROM content, as shown in Fig 39. The generated example byte stream with two entries (0x02010A010003090100) must be stored into the EEPROM 0x201368 ... 0x2013a7.

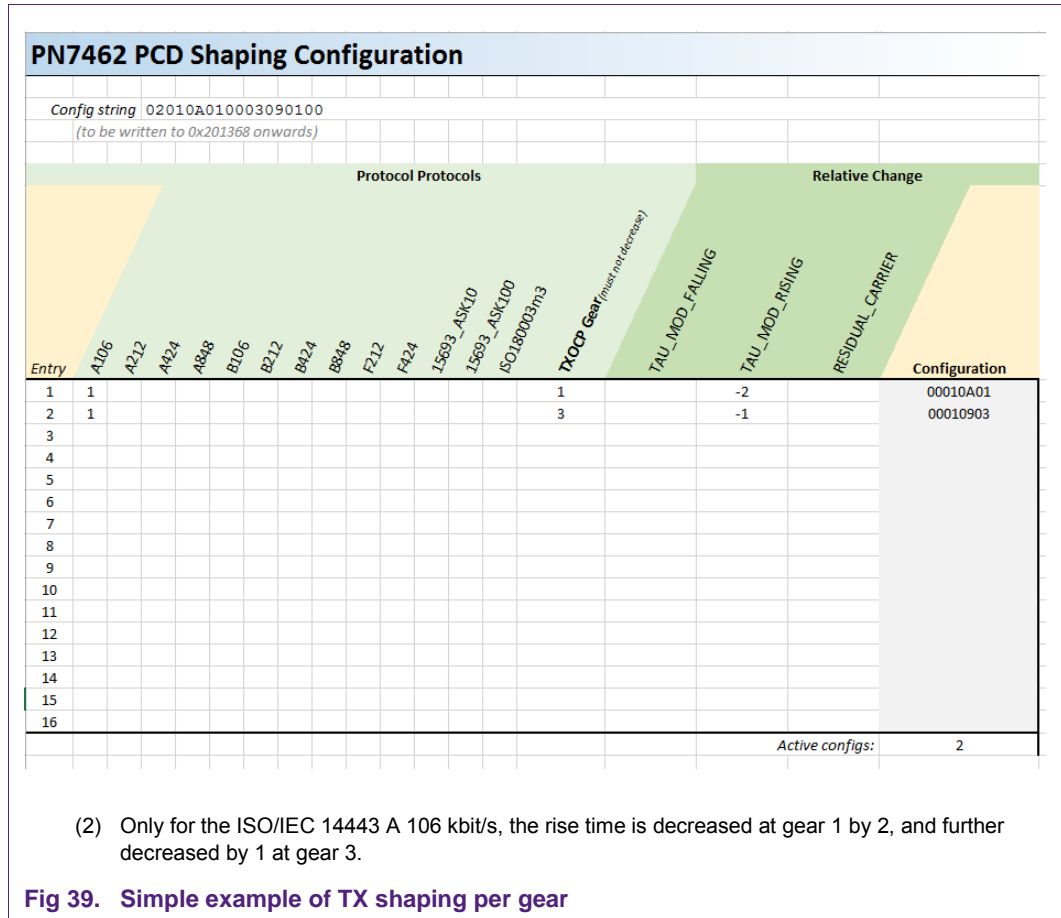

### 4.9.3 Example with Tx Shaping Configuration per gear per protocol

Changing the load by reducing the operating distance of the Reference PICC changes the gear and the envelope. Fig 40 shows the example using the default load protocol settings as defined in section 4.7.1, when the load is changed and the gear has switched from gear 0 to gear 1. It still passes, but the rise time t4 is very close to the limit. So it would be safe to reduce the rise time by changing the TAU\_MOD\_RISING.



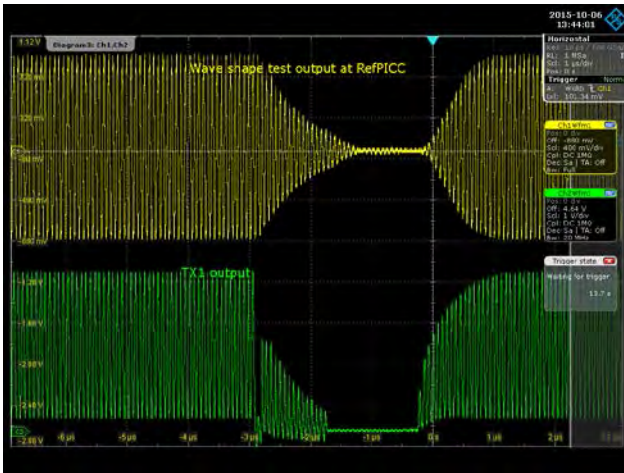

c. Screenshot from the Oscilloscope

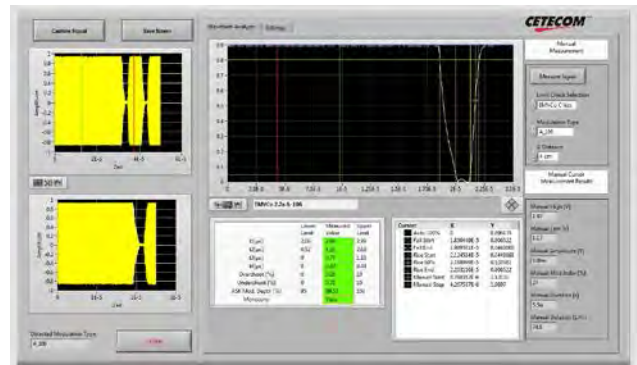

d. Screenshot from CETECOM WaveChecker

Fig 40. Type A almost bad in gear 1

This can be done with the NFC Cockpit, i.e. reading the TX Shaping settings indicates that the TAU\_MOD\_RISING has been set to 3 as shown in Table 12.

Table 12. EMVCo Type A with TX Shaping (gear 0)

Setting	Value (bin)	Comment
TX_UNDERSHOOT_PATTERN_LEN	1111	
TX_UNDERSHOOT_PROT_ENABLE	1	
TX_RESIDUAL_CARRIER	11110	
TX_SET_BYPASS_SC_SHAPING	0	
TX_SET_TAU_MOD_FALLING	0100	
TX_SET_TAU_MOD_RISING	0011	This parameter defines the rise time and should be reduced in gear 1.
TX_CLK_MODE_OVUN_PREV	101	
TX_CLK_MODE_RM	001	

Changing the TAU\_MOD\_RISING manually to 1 reduces the t4 from 0.44µs to 0.39µs, as shown in Fig 41.



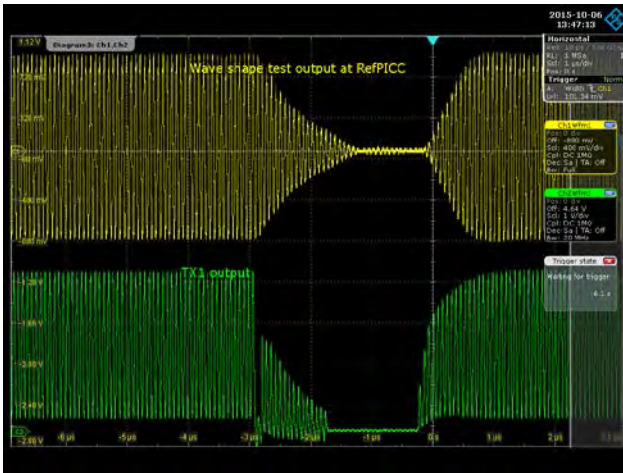

e. Screenshot from the Oscilloscope

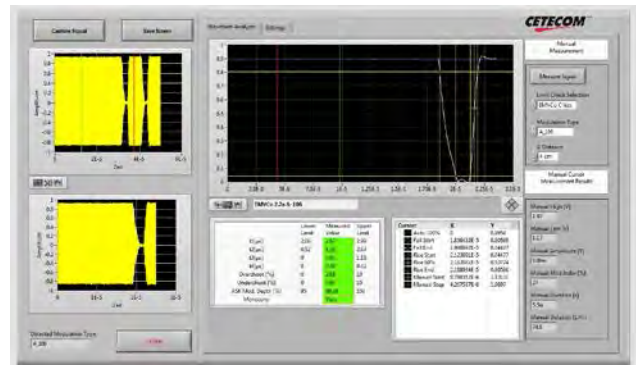

f. Screenshot from CETECOM WaveChecker

Fig 41. Type A good in gear 1

The PN7462 PCD Shaping Configuration tool (Excel sheet) allows now to enter the first entry of TX Shaping parameter change per gear and protocol, as shown in Fig 42.

This entry is only valid for the ISO/IEC 14443 type A at 106 for gear 1 and all higher gears. It defines a decrease of TAU\_MOD\_RISING by 2, as soon as the PN7462 switches from gear 0 to gear 1. Switching back from gear 1 to gear 0 returns to the original value of TAU\_MOD\_RISING.

The Excel macro automatically generates the configuration string 0x01010A0100, which must be stored into the EEPROM starting at address 0x201368.

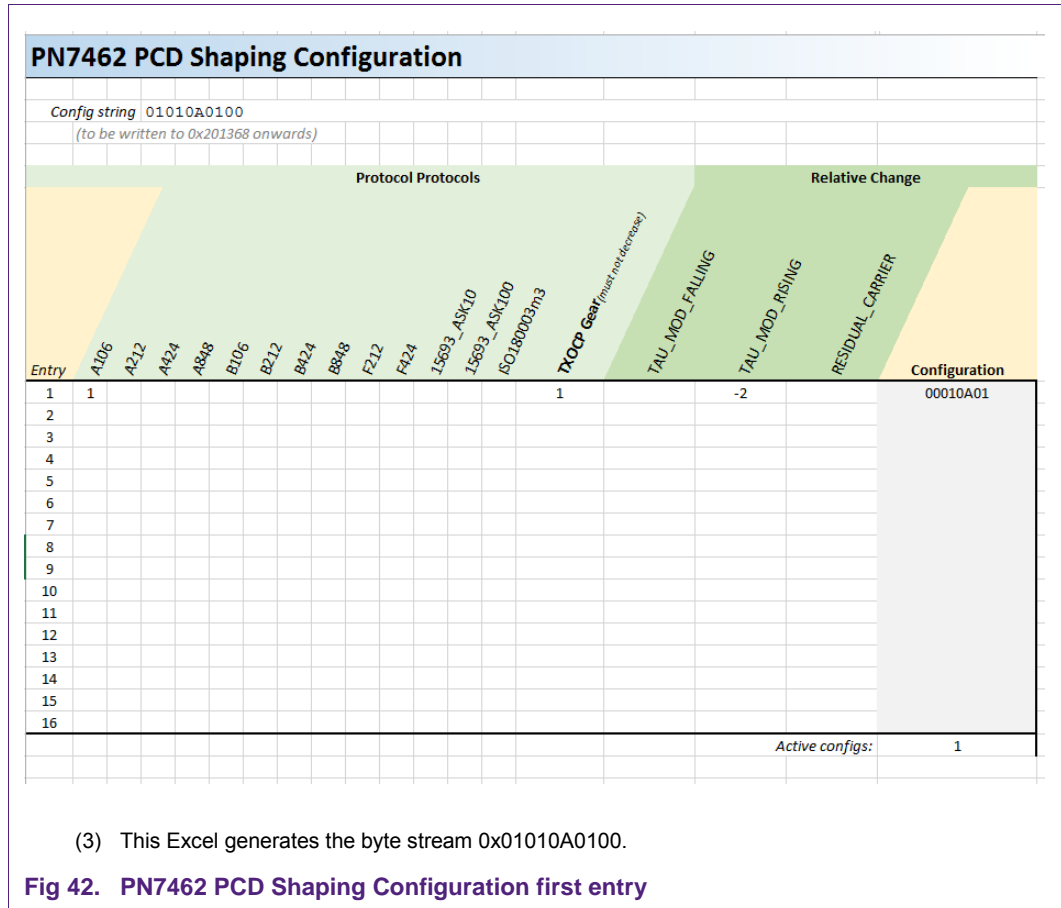

In the next step the same test is made with type B. The load protocol uses the settings as defined in section 4.7.2. (see Table 8). Changing from gear 0 to gear it turns out that the modulation index increases. It still passes the limits as shown in Fig 43g, but the modulation index ( $m = 13.5$ ) is quite close to the limit of 14. So the TX\_RESIDUAL\_CARRIER can be reduced e.g. by 1, which reduces the modulation index ( $m = 12.8$ ).

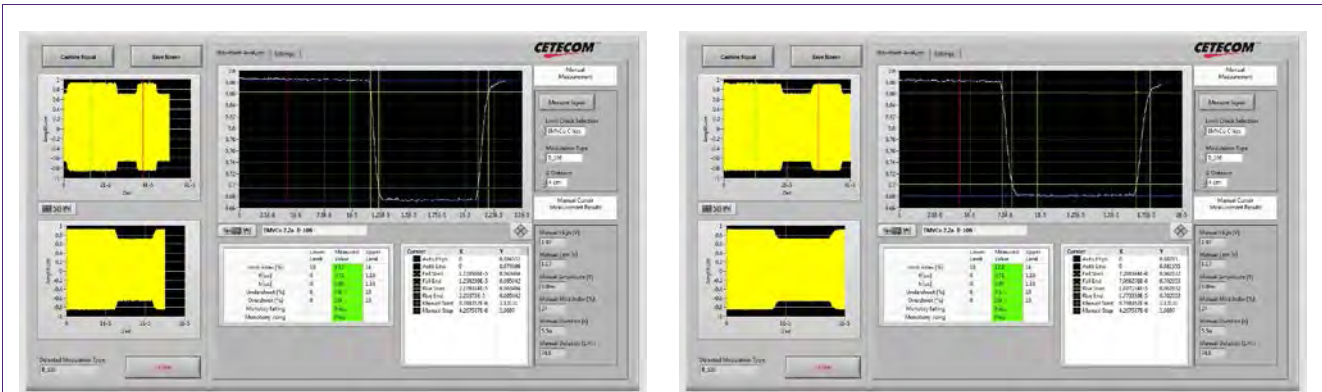

g. Screenshot from CETECOM WaveCheck  
 h. Almost bad (m = 13.5)

i. Screenshot from CETECOM WaveCheck  
 j. Good after correction (m = 12.8)

Fig 43. Type B gear 1

This required change must be added to the PCD Shaping Configuration tool as shown in Fig 44.

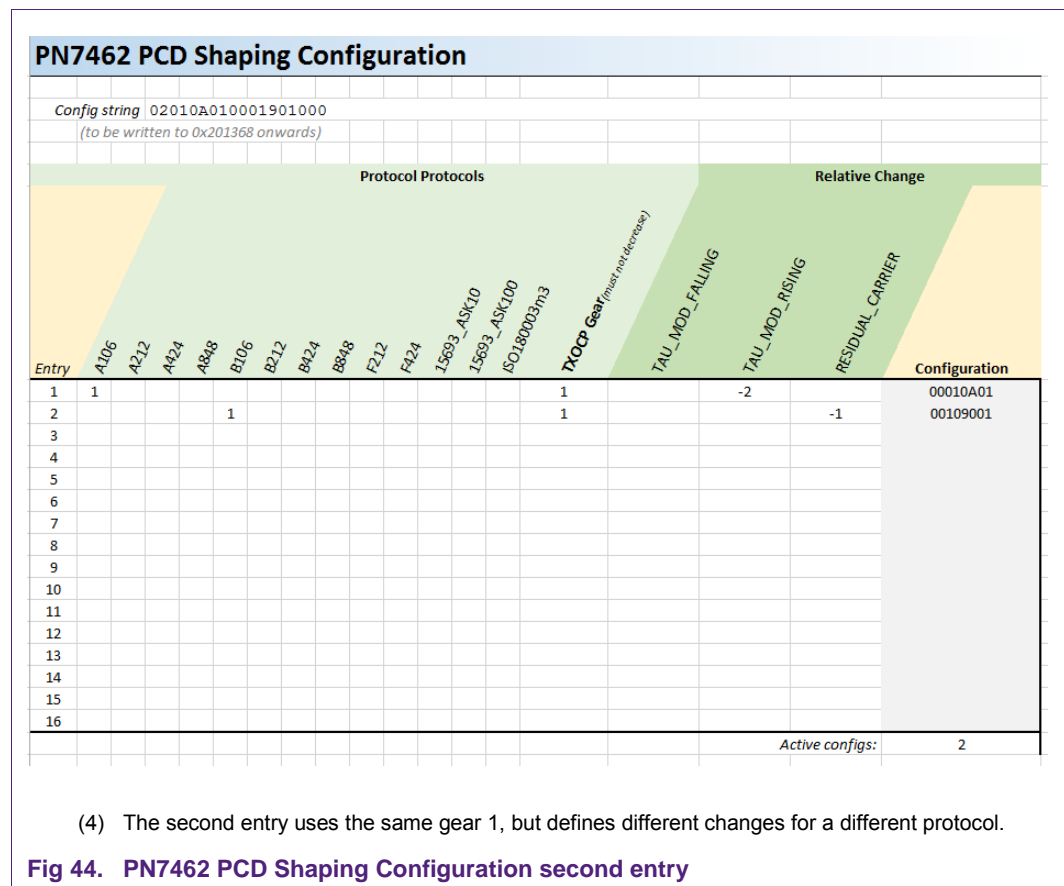

Fig 44. PN7462 PCD Shaping Configuration second entry

In the next steps the next gears are checked for each type A and B. For gear 2 e.g. the type B modulation should be further reduced to not get too close to the limit (refer to Fig 45). A decrease of the TX\_RESIDUAL\_CARRIER by 2 changes m = 13.6 into m = 12.3.



## 5. Trim Procedure

---

Each production device must be trimmed with a device specific DPC\_XI value. This should be done during the device testing after production.

### **Trim procedure steps for each production device:**

- 1) Load the Reference EEPROM values into the EEPROM.
- 2) Load Protocol (e.g. for type A 106).
- 3) Enable the RF field, no loading applied.
- 4) Read RF\_STATUS. If gear >0, then
  - a. Read DPC\_AGC\_GEAR\_LUT\_SIZE
  - b. Write 0x01 into DPC\_AGC\_GEAR\_LUT\_SIZE to force the device into gear 0
  - c. Reset RF Field
  - d. Read RF\_STATUS
  - e. Restore DPC\_AGC\_GEAR\_LUT\_SIZE to previous value.
- 5) Calculate the DPC\_XI value:
$$\text{DPC\_XI value} = \text{Reference AGC value (from "golden device")} - \text{current AGC value (bit 0...9 from RF\_STATUS)}$$
- 6) Write DPC\_XI value into DPC\_XI EEPROM.
- 7) Perform SoftReset, in case the correct DPC function shall be tested immediately.

**Note:** After the trim procedure the DPC must switch gear at the same ITVDD limit like the Reference device.

## 6. References

---

- [1] AN11740 PN5180 antenna design guide, [www.nxp.com](http://www.nxp.com)
- [2] AN11741 How to design an antenna with DPC, [www.nxp.com](http://www.nxp.com)
- [3] UM10858 PN7462 HW user manual, [www.nxp.com](http://www.nxp.com)
- [4] AN11744 PN5180 Evaluation Board quick start guide, [www.nxp.com](http://www.nxp.com)

## 7. Annex

Example measurement of AGC values per gear of the same antenna like the example antenna from [2], using the same DPC antenna tuning. However, here the AGC values are lower, since a higher Rx coupling resistor has been used.

**Table 13. Example measurement of DPC\_THRSH\_HIGH**

*The Rx resistor = 5.1kΩ, so the nominal AGC value unloaded is too low.*

Gear #	AGC (hex)	AGC (dec)	Loading	ITVDD
0	0F3	243 (should be 300)	Unloaded	139
0	140	320	1	180
1	10C	268	1	151
1	13B	315	2	180
2	0FC	252	2	141
2	140	320	3	180
3	0D6	214	3	122
3	124	292	4	180
4	03B	59	4	75
4	04D	77	5	76

## 8. Legal information

### 8.1 Definitions

**Draft** — The document is a draft version only. The content is still under internal review and subject to formal approval, which may result in modifications or additions. NXP Semiconductors does not give any representations or warranties as to the accuracy or completeness of information included herein and shall have no liability for the consequences of use of such information.

### 8.2 Disclaimers

**Limited warranty and liability** — Information in this document is believed to be accurate and reliable. However, NXP Semiconductors does not give any representations or warranties, expressed or implied, as to the accuracy or completeness of such information and shall have no liability for the consequences of use of such information. NXP Semiconductors takes no responsibility for the content in this document if provided by an information source outside of NXP Semiconductors.

In no event shall NXP Semiconductors be liable for any indirect, incidental, punitive, special or consequential damages (including - without limitation - lost profits, lost savings, business interruption, costs related to the removal or replacement of any products or rework charges) whether or not such damages are based on tort (including negligence), warranty, breach of contract or any other legal theory.

Notwithstanding any damages that customer might incur for any reason whatsoever, NXP Semiconductors' aggregate and cumulative liability towards customer for the products described herein shall be limited in accordance with the *Terms and conditions of commercial sale* of NXP Semiconductors.

**Right to make changes** — NXP Semiconductors reserves the right to make changes to information published in this document, including without limitation specifications and product descriptions, at any time and without notice. This document supersedes and replaces all information supplied prior to the publication hereof.

**Suitability for use** — NXP Semiconductors products are not designed, authorized or warranted to be suitable for use in life support, life-critical or safety-critical systems or equipment, nor in applications where failure or malfunction of an NXP Semiconductors product can reasonably be expected to result in personal injury, death or severe property or environmental damage. NXP Semiconductors and its suppliers accept no liability for inclusion and/or use of NXP Semiconductors products in such equipment or applications and therefore such inclusion and/or use is at the customer's own risk.

**Applications** — Applications that are described herein for any of these products are for illustrative purposes only. NXP Semiconductors makes no representation or warranty that such applications will be suitable for the specified use without further testing or modification.

Customers are responsible for the design and operation of their applications and products using NXP Semiconductors products, and NXP Semiconductors accepts no liability for any assistance with applications or customer product design. It is customer's sole responsibility to determine whether the NXP Semiconductors product is suitable and fit for the customer's applications and products planned, as well as for the planned application and use of customer's third party customer(s). Customers should provide appropriate design and operating safeguards to minimize the risks associated with their applications and products.

NXP Semiconductors does not accept any liability related to any default, damage, costs or problem which is based on any weakness or default in the customer's applications or products, or the application or use by customer's third party customer(s). Customer is responsible for doing all necessary testing for the customer's applications and products using NXP Semiconductors products in order to avoid a default of the applications and the products or of the application or use by customer's third party customer(s). NXP does not accept any liability in this respect.

**Export control** — This document as well as the item(s) described herein may be subject to export control regulations. Export might require a prior authorization from competent authorities.

**Translations** — A non-English (translated) version of a document is for reference only. The English version shall prevail in case of any discrepancy between the translated and English versions.

**Evaluation products** — This product is provided on an "as is" and "with all faults" basis for evaluation purposes only. NXP Semiconductors, its affiliates and their suppliers expressly disclaim all warranties, whether express, implied or statutory, including but not limited to the implied warranties of non-infringement, merchantability and fitness for a particular purpose. The entire risk as to the quality, or arising out of the use or performance, of this product remains with customer.

In no event shall NXP Semiconductors, its affiliates or their suppliers be liable to customer for any special, indirect, consequential, punitive or incidental damages (including without limitation damages for loss of business, business interruption, loss of use, loss of data or information, and the like) arising out the use of or inability to use the product, whether or not based on tort (including negligence), strict liability, breach of contract, breach of warranty or any other theory, even if advised of the possibility of such damages.

Notwithstanding any damages that customer might incur for any reason whatsoever (including without limitation, all damages referenced above and all direct or general damages), the entire liability of NXP Semiconductors, its affiliates and their suppliers and customer's exclusive remedy for all of the foregoing shall be limited to actual damages incurred by customer based on reasonable reliance up to the greater of the amount actually paid by customer for the product or five dollars (US\$5.00). The foregoing limitations, exclusions and disclaimers shall apply to the maximum extent permitted by applicable law, even if any remedy fails of its essential purpose.

### 8.3 Licenses

#### Purchase of NXP ICs with NFC technology

Purchase of an NXP Semiconductors IC that complies with one of the Near Field Communication (NFC) standards ISO/IEC 18092 and ISO/IEC 21481 does not convey an implied license under any patent right infringed by implementation of any of those standards. Purchase of NXP Semiconductors IC does not include a license to any NXP patent (or other IP right) covering combinations of those products with other products, whether hardware or software.

### 8.4 Trademarks

Notice: All referenced brands, product names, service names and trademarks are property of their respective owners.

**MIFARE** — is a trademark of NXP B.V.



## 9. List of figures

Fig 1.	Loading of a typical DPC antenna tuning.....	4	Fig 45.	Type B gear 2.....	51
Fig 2.	DPC principle.....	5	Fig 46.	PN7462 PCD Shaping Configuration final.....	51
Fig 3.	DPC Gears in principle.....	6			
Fig 4.	RF Field on with DPC.....	8			
Fig 5.	TX Power setting bit 0...3.....	9			
Fig 6.	Example of ITVDD versus Gear.....	11			
Fig 7.	Correlation between AGC and ITVDD.....	15			
Fig 8.	Correlation example.....	16			
Fig 9.	Jumper of the PN5180 Evaluation board.....	17			
Fig 10.	Jumper of the PN7462 Evaluation board.....	18			
Fig 11.	Correlation test steps 1...4.....	19			
Fig 12.	Correlation test step 5.....	20			
Fig 13.	Correlation test start of second loading case...21	21			
Fig 14.	Correlation test last step.....	22			
Fig 15.	Correlation test result.....	23			
Fig 16.	DPC Calibration Step 1.....	24			
Fig 17.	DPC Calibration Step 2.....	25			
Fig 18.	DPC Calibration Step 3.....	25			
Fig 19.	DPC Calibration start with gear 0.....	26			
Fig 20.	DPC Calibration finish gear 0.....	27			
Fig 21.	DPC calibration with gear 1.....	27			
Fig 22.	DPC calibration storing the DPC settings.....	28			
Fig 23.	PN5180 Type A pulse, no shaping.....	29			
Fig 24.	Tx Shaping principle 1.....	30			
Fig 25.	Tx Shaping principle 2.....	30			
Fig 26.	TX shaping test setup.....	31			
Fig 27.	TX undershoot patter length.....	34			
Fig 28.	TX Undershoot pattern.....	34			
Fig 29.	TX undershoot residual carrier.....	35			
Fig 30.	TX Overshoot Residual carrier.....	35			
Fig 31.	TX undershoot Fall time behavior.....	36			
Fig 32.	TX overshoot Rise time behavior.....	36			
Fig 33.	Example antenna.....	39			
Fig 34.	EMVCo Type A without TX Shaping (fail).....	39			
Fig 35.	EMVCo Type A with TX Shaping (pass).....	40			
Fig 36.	EMVCo Type B without TX Shaping (fail).....	41			
Fig 37.	EMVCo Type B with TX Shaping (pass).....	42			
Fig 38.	AWC with PN5180 NFC Cockpit.....	45			
Fig 39.	Simple example of TX shaping per gear.....	46			
Fig 40.	Type A almost bad in gear 1.....	47			
Fig 41.	Type A good in gear 1.....	48			
Fig 42.	PN7462 PCD Shaping Configuration first entry.....	49			
Fig 43.	Type B gear 1.....	50			
Fig 44.	PN7462 PCD Shaping Configuration second entry.....	50			

## 10. List of tables

---

Table 1.	Relevant parameters of the DPC (PN5180).....	6
Table 2.	TX Power Settings (bit 7...0).....	9
Table 3.	Example of Tx Output settings (15 gears).....	10
Table 4.	Example of Tx Output power settings (5 gears).....	10
Table 5.	Example measurement of DPC_THRSH_HIGH.....	12
Table 6.	Example PN5180 EEPROM content for DPC_THRSH_HIGH.....	13
Table 7.	EMVCo Type A with TX Shaping.....	40
Table 8.	EMVCo Type B with TX Shaping.....	41
Table 9.	Simple example of TX shaping per gear.....	43
Table 10.	Entry table in the EEPROM.....	43
Table 11.	PCD Shaping entry definition.....	44
Table 12.	EMVCo Type A with TX Shaping (gear 0).....	47
Table 13.	Example measurement of DPC_THRSH_HIGH.....	53

## 11. Contents

<b>1.</b>	<b>Introduction</b> .....	<b>3</b>	4.4.2.3	TX_SET_TAU_MOD_FALLING .....	35
1.1	The principle of DPC .....	4	4.4.2.4	TX_SET_TAU_MOD_RISING .....	36
1.2	Parameters of DPC .....	6	4.4.2.5	TX_CLK_MODE_OVUN_PREV .....	36
1.2.1	DPC_CONTROL .....	7	4.5	Remove undershoot .....	37
1.2.1.1	Bit 0: Enable DPC .....	7	4.6	Remove overshoot .....	38
1.2.1.2	Bit 1...3: Gear step size .....	7	4.7	Examples .....	39
1.2.1.3	Bit 4...7: Start gear .....	7	4.7.1	Example of a TX shaping setting for type A .....	39
1.2.2	DPC_AGC_GEAR_LUT_SIZE .....	7	4.7.2	Example of a TX shaping setting for type B .....	41
1.2.3	DPC_AGC_GEAR_LUT (TX Output power settings) .....	8	4.8	Tx Shaping per DPC gear per protocol (AWC) .....	42
1.2.4	DPC_THRSH_HIGH .....	11	4.8.1	Simple example of a delta value per gear .....	43
1.2.4.1	DPC_THRSH_HIGH Example with 5 gears .....	12	4.8.2	Entry table for the Tx Shaping per gear .....	43
1.2.5	DPC_AGC_SHIFT_VALUE .....	13	4.9	AWC Tools for PN5180 and PN7462 .....	44
1.2.6	DPC_XI .....	14	4.9.1	AWC in the NFC Cockpit (PN5180) .....	44
1.2.6.1	Define Reference AGC value .....	14	4.9.2	AWC with Excel sheet (PN7462) .....	45
1.2.6.2	Trim production device .....	14	4.9.3	Example with Tx Shaping Configuration per gear per protocol .....	46
<b>2.</b>	<b>DPC Correlation test</b> .....	<b>15</b>	<b>5.</b>	<b>Trim Procedure</b> .....	<b>52</b>
2.1	Correlation test .....	15	<b>6.</b>	<b>References</b> .....	<b>52</b>
2.2	Correlation test with the NFC Cockpit .....	16	<b>7.</b>	<b>Annex</b> .....	<b>53</b>
2.2.1	PN5180 .....	16	<b>8.</b>	<b>Legal information</b> .....	<b>54</b>
2.2.2	PN7462 .....	17	8.1	Definitions .....	54
2.2.3	Step 1: ITVDD unloaded .....	18	8.2	Disclaimers .....	54
2.2.4	Step 2: Step size .....	19	8.3	Licenses .....	54
2.2.5	Step 3: ITVDD max .....	19	8.4	Trademarks .....	54
2.2.6	Step 4: Start correlation test .....	19	<b>9.</b>	<b>List of figures</b> .....	<b>55</b>
2.2.7	Step 5: ITVDD / AGC measurement loading case 1 .....	20	<b>10.</b>	<b>List of tables</b> .....	<b>56</b>
2.2.8	Step 6: ITVDD / AGC measurement loading case 2 .....	21	<b>11.</b>	<b>Contents</b> .....	<b>57</b>
2.2.9	Step 7: Store the result .....	22			
<b>3.</b>	<b>DPC calibration</b> .....	<b>23</b>			
3.1	Prerequisites .....	23			
3.2	DPC Calibration minimum requirements .....	23			
3.3	Calibration procedure with the NFC Cockpit .....	24			
<b>4.</b>	<b>Tx Shaping</b> .....	<b>29</b>			
4.1	Tx Shaping principle .....	29			
4.2	Wave shape test set up .....	31			
4.3	Differences PN5180 versus PN7462 .....	32			
4.3.1	PN5180 relevant registers .....	32			
4.3.2	PN7462 relevant registers .....	32			
4.4	PN5180 and PN7462 relevant settings .....	33			
4.4.1.1	TX_UNDERSHOOT_PROT_ENABLE .....	33			
4.4.1.2	TX_UNDERSHOOT_PATTERN_LEN .....	33			
4.4.2	TX_UNDERSHOOT_PATTERN .....	34			
4.4.2.1	TX_RESIDUAL_CARRIER .....	34			
4.4.2.2	TX_SET_BYPASS_SC_SHAPING .....	35			

Please be aware that important notices concerning this document and the product(s) described herein, have been included in the section 'Legal information'.